



# Ground application. Ice & Snow Melting

Application manual



# Index

1. Application Briefing	4
2. System Description	5
3. Products	6
4. System Design	10
5. Installation	15
6. Appendixes	19
7. Cases	24

# Let DEVI do the work

DEVI - an abbreviation of Dansk El-Varme Industri – was established in Copenhagen, Denmark, in 1942. As from January 1st 2003 DEVI has become a part of the Danfoss Group - Denmark's largest industrial Group. Danfoss is one of the world's leading companies within heating, cooling and air-conditioning. The Danfoss Group has more than 23.000 employees and serves customers in more than 100 countries.

DEVI is Europe's leading brand of electrical cable heating systems and electric pipe heating systems with over 70 years of experience. The production of heating cables takes place in France and Poland while the head office is situated in Denmark.

## The value of experience

We have installed literally thousands of systems across the globe, in every conceivable setting. This experience means that we can offer you practical advice about precisely which components you need to get the best results at the lowest cost.

## Ground application. Ice & Snow Melting

This design guide presents DEVI's recommendations for design and installation of ice and snow melting systems for ground application. It provides guidance for heating cable positioning, electrical data and system configurations.

Following DEVI's recommendations will ensure energy efficient, reliable and maintenance free solution for constant wattage heating cables with 20 year warranty.

## Our quality management system **certifications and compliances**

✓ ISO 9001    ✓ TS 16949

✓ ISO 14001

Along with full compliance with EU directives and product approvals



# 1. Application Briefing

## Winter weather costs

In recent years there have been plenty of new stories about human and financial costs caused by harsh winter weather. Property damage, increased maintenance expenses, lost productivity, rising insurance premiums, personal injuries and even worse. Installation of DEVI Ice & Snow Melting System ensures a steady solution to address cold weather related problems.

DEVI's ice and snow melting system is designed to provide safety for people, vehicles, and buildings safety through safe walking and driving during winter and safety in terms of less damage to buildings.

## Ground solutions – with a first class product range

By using DEVI heating cables and mats controlled by electronic thermostats with moisture sensors, you can cost-effectively protect large areas such as parking areas, ramps or pedestrian accesses to buildings giving you convenience and safety while saving a lot of tiring and time-consuming manual work.

One of the greatest advantages of these systems is the most energy efficient solution for the ground ice and snow melting applications.

## Benefits

- **Efficient snow removal** - area is kept free from ice and snow at all times
- **No manual snow removal** and salting becomes unnecessary.
- **Safe traffic and working areas** for people
- **Flexible system** for most common surface covering materials
- **Cost saving** for outdoor surface repair after winter
- **Environment is protected** against salting and antifreeze related damages.
- Automatic **"Around the Clock"** snow clearing service.
- Smart 2-zone control with **low energy consumption**
- **Prioritizing** – limited power output solution
- **PVC free**, twin conductors heating cables and mats (IEC 60800)
- A maintenance free system with **20 year full warranty** on cables



## 2. System Description

Main purpose of the system is to melt and remove snow and ice from ground surfaces.

The most common DEVI ice and snow melting ground applications are in residential car parking areas, driveways, pavements, outdoor steps, loading platforms, ramps, bridges and drainage areas. It is even possible to melt snow and ice on mastic asphalt surfaces by using special heating cables.

When heating cables are installed to melt snow or slippery ice on the ground, safety and cost saving go hand in hand.

It can be done manually or in a smart way – by means of electrical Ice & Snow Melting system with thermostat control and moisture and temperature sensors that can control 2 zones simultaneously. Inactive during cold but dry weather 2 zone control saves energy and reduces costs.

The automatic regulation of the snow melting system keeps areas free from snow and passable at all times – night and day.

When installing ice and snow melting systems on steep slopes it may be necessary to provide some drainage for melted water at the slope bottom. The drain system should also be protected against ice formations.



# 3. Products

Electrical heating system consists of two major components:

- Heating element – heating cable or heating mat;
- Thermostat with a temperature sensor or regulator/controller with temperature and moisture sensor(s).

Heating cables and mats for Ground applications are usually installed into concrete construction or into special glue under tiles.

DEVI heating cables and mats for Ground applications are designed for installation in concrete constructions or into special glue under tiles. Usual thickness of top/finish concrete layer for outdoor applications is at least 5 cm. But the thickness should comply with a ground construction and local norms and regulations.

Heating cables used in ground constructions are serial resistive cables, single or twin conductor. Most of cables and mats are manufactured as ready-to-install heating elements with a specific length (i.e. 7, 10, 15, up to 229 m), with connecting power supply cable (cold lead or cold tail) and sealed joints (muffs or end terminals).

Range of heating cables linear output for ground application is usually 15-30 W/m. DEVI ready-made cables are available with 18, 20, 30 W/m output (for 230 and 400 V).

Heating mats are available with 300 W/m<sup>2</sup> output.

Most DEVI cables are manufactured and approved in accordance with the latest revision of IEC 60800:2009, with M2 mechanical strength class (for rough concrete constructions).

The main type of DEVI heating cables is twin conductor heating cables. Internal design of a modern twin conductor DEVIflex™ cable are shown in the figure below.

## Heating elements

For Ground Ice and Snow Melting systems the following resistive (constant wattage) heating elements can be used.

Heating cables:

- Twin conductor DEVIflex™ 18T and DEVIflex™ 20T (230 V);
- Single conductor DEVIbasic™ 20S (230/400 V);
- Single conductor DEVIbasic™ on drum (max. 400 V);
- Twin conductor DEVIsafe™ 20T (230/400 V);
- Twin conductor DEVIsnow™ 20T and DEVIsnow™ 30T (230/400 V);
- Single conductor DEVIsnow™ on drum ( max 400 V);
- Twin conductor DEVIasphalt™ 30T (400 V);

Heating mats:

- Twin conductor DEVIsnow™ 300T (230/400 V);
- Twin conductor DEVIasphalt™ 300T (230/400 V).

**Note.** The number at the end of the cable's and mat's name refers to its linear output – W/m or area output – W/m<sup>2</sup>, at 230 V or 400 V. Letter "T" means twin conductor cable/mat (Twin), letter "S" – single-conductor cable/mat (Single).

DEVI resistive heating cables ensure safe, efficient and economical ground application.

To ensure long life-time and quality all cables are thoroughly inspected including tests for ohmic resistance, high voltage and material control.

The most used heating elements for Ground Ice and Snow Melting systems are DEVIbasic™, DEVIflex™ and DEVIsafe™ 20T heating cables and DEVIsnow™ 300T heating mat.

**DEVIflex™.** It is a twin conductor fully screened heating cable for installation in concrete, pipe heating etc. The cable complies with IEC 60800:2009 class M2, and is designed for applications with the high risk of mechanical damage. It is supplied in readymade sets with 2,3 m cold lead, sealed joints and end muffs.

Cable diameter is Ø 6,9 mm.

The cable is available for 230 V power supply.

Cables of 18 and 20 W/m (230 V) linear output are available.

Cable length:  
DEVIflex™ 18T: 7-170 m ;  
DEVIflex™ 20T: 7,1-163 m.



DEVIflex™

**DEVIbasic™.** It's a single conductor screened heating cable complied with IEC 60800:1992 class C and intended for installation in concrete, for pipe heating etc. It's supplied in readymade sets with 2 x 3 m cold leads and 2 sealed connection muffs.

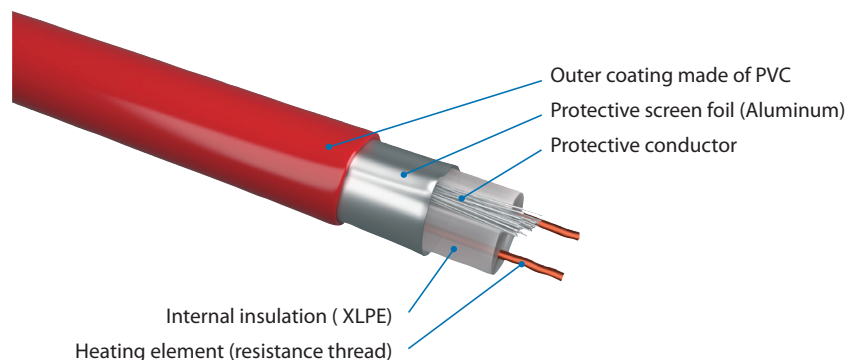

DEVIflex™ heating cable construction

Cable diameter is Ø 5,5 mm.

DEVbasic™ 20S is available with 20 W/m output in 2 options for 230 V and 400 V power supply.

Cable length:

DEVbasic™ 20S, 230 V: 9-228 m;  
DEVbasic™ 20S, 400 V: 56-229 m.

DEVbasic™ on drum is possible to use with max. 400 V power supply and max. linear output of 20 W/m.

Available Ohm/m range:  
0,0134-34,1 Ohm/m.



DEVbasic™ 20S readymade

**DEVsafe™.** It is a twin conductor fully screened heating cable for installation on roofs, in gutters, down drain pipes and on the ground. The cable has UV stable tough outer sheath which complies with IEC



DEVbasic™ on drum

60800:2009 class M2, and is designed for applications with the high risk of mechanical damage. It is supplied in readymade sets with 2,5 m cold lead, sealed joints and end muffs.

Cable diameter is Ø 7 mm.

The cable is available with linear output of 20 W/m in 2 options for 230 V and 400 V power supply.

Cable length:

DEVsafe™ 20T, 230 V: 6-194 m;  
DEVsafe™ 20T, 400 V: 21-205 m.

**DEVIsnow™.** It is a twin conductor fully screened heating cable for installation mainly on roofs, in gutters, down drain pipes. It can be an option for installation on the ground too. The cable has UV stable tough outer sheath, FEP conductor insulation, it complies with IEC 60800:2009 class M2 and is designed for applications with the high risk of mechanical damage. It is supplied in readymade sets with 2,5 m cold lead, sealed joints and end muffs.

Twin conductor DEVIsnow™ 300T heating mat can be recommended for fast, simple and safe installation on the ground.



DEVIsnow™

Mat is available for two power supply options – 230 and 400 V.

Output is 300 W/m<sup>2</sup> at 230/400 V.

Mat width options – 0,5, 0,75 and 1 m.

Available size:

for 0,5 width m: 1-12 m<sup>2</sup> for 230 V  
and 1,7-7,3 m<sup>2</sup> for 400 V;  
for 0,75 width m: 1,4-12 m<sup>2</sup> for 230 V  
and 3,2-28,2 m<sup>2</sup> for 400 V;  
for 1 m width: 3-12 m<sup>2</sup> for 230 V  
and 6-19 m<sup>2</sup> for 400 V.



DEVIsnow™ mat

**DEViasphalt™.** Cables and mats with extremely high-quality consisted of a 360° fully screened twin conductor cable with highly robust UV stable outer sheath.

Designed specifically for embedding in mastic asphalt with maximum temperature of 240°C.



DEViasphalt™

For more details please refer to the "Asphalt application. Ice & Snow Melting" Application manual.



DEViasphalt™ mat

### Fixing

In case of heating cables application, it is recommended to use fittingbands to fix the cable to the base, e.g. DEVifast™ metal galvanized fitting band (see Appendix A.2). It should be attached to the ground (e.g. nailed down) in parallel lines usually at intervals of 50 cm or using 2 meters of fitting band per each square meter of cable installation. The same applies to DEVclip™ C-C and Montagestege™ plastic bands.

For quick cable fixing to reinforced mesh DEVclip™ Twist plastic fixing is recommended.



DEVifast™

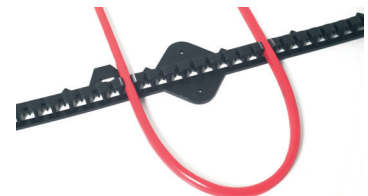

DEVclip™ C-C



Montagestege™



DEVclip™ Twist

## Control

Ice and snow melting systems are different and require different thermostats/regulators.

DEVlreg™ thermostats and regulators are fitted with a complete set of control functions for heating systems for ice and snow melting of any type and allow attaching external sensors for measuring ground temperature as well as control of moisture conditions.

The product range of controls is designed for ground outdoor systems including the following:

- thermostats with a temperature sensor – DEVlreg™ 330 (5...45 °C), DEVlreg™ 610;
- regulator with an integrated temperature and moisture sensor(s) – DEVlreg™ 850.

To control simple or low output systems a thermostat with a ground temperature sensor is recommended. DEVlreg™ 330 (5...45 °C) thermostat with the DIN rail attachment is recommended as a standard solution.

It can be also used on wall/pipe mounted DEVlreg™ 610, IP44.

As an alternative to control small areas near private houses etc. DEVlreg™ 130 wall mounted room thermostat can be used.

All thermostats above are supplied with a wire temperature sensor – NTC 15 kOhm @25 °C, 3 m.

To control ice and snow melting systems especially with high output the best solution is DEVlreg™ 850 regulator/controller with integrated ground and roof moisture and temperature sensors.

DEVlreg™ 850 is a two-zone controller with possibility of connection up to 4 sensors to provide maximum control of the outdoor heating system. Comparing to installations with typical ground temperature measuring this regulator ensures reducing energy consumption costs by up to 40%.



DEVlreg™ 330 (5...45 °C)  
with wire sensor in set



DEVlreg™ 850  
with ground sensor



DEVlreg™ 610



DEVlreg™ 130

## Zone support saves energy

The DEVlreg™ 850 lets you divide your area in to 2 zones, e.g. a North and South side. In this way it is possible to save energy, when the South side is free of ice and snow faster because of the heat from the sun.

## Prioritizing – for limited power output

You can prioritize between the zones, e.g. if you have limited power output. This way one zone is made ice and snow free before focus is put on the other zone.

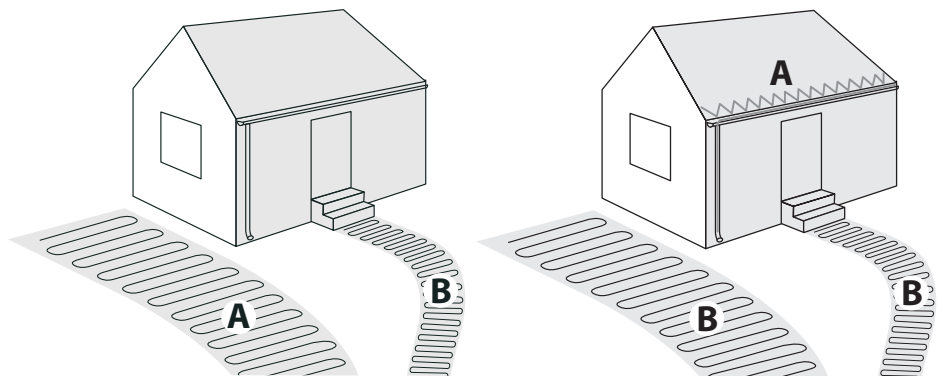



## Products – general overview for Ground ice and snow melting systems

Product	Options	Description
DEVIflex™ Resistive heating cable	DEVIflex™ 18T, 230 V; DEVIflex™ 20T, 230 V	Twin conductor, 100% screen, red. 18, 20 W/m (230 V). DIN IEC 60800:2009 M2
DEVlbasic™ 20S Resistive heating cable	DEVlbasic™ 20S, 230 & 400 V program	Single conductor, wire screen, red. 20 W/m (230/400 V). DIN IEC 60800:1992 C
DEVlbasic™ Resistive heating cable	DEVlbasic™ on drum; 0,0134-34,1 Ohm/m	Single conductor, wire screen, red. Max. 20 W/m; max. 400 V. DIN IEC 60800:1992 C
DEVlsafe™ 20T Resistive heating cable	DEVlsafe™ 20T, 230 & 400 V program	Twin conductor, 100% screen, UV stable, black. 20 W/m (230/400 V). DIN IEC 60800:2009 M2
DEVlsnow™ Resistive heating cable	DEVlsnow™ 20T, 230 & 400 V program; DEVlsnow™ 30T, 230 & 400 V program	Twin conductor, 100% screen, FEP conductor insulation, UV stable, black. 20 and 30 W/m (230/400 V). DIN IEC 60800:2009 M2
DEVlsnow™ Resistive heating cable	DEVlsnow™ on drum, 0,055-9,36 Ohm/m	Twin conductor, 100% screen, FEP conductor insulation, UV stable, black. Max. 30 W/m, max. 400 V. DIN IEC 60800:2009 M2
DEVlsnow™ 300T Resistive heating mat	DEVlsnow™ 300T, 230 & 400 V program	Twin conductor, 100% screen, FEP conductor insulation, UV stable, black. 300 W/m <sup>2</sup> (230/400 V).
DEVlasphalt™ Resistive heating cable	DEVlasphalt™ 30T 400 V program	Twin conductor, 100% screen, UV stabilized, black, short term contact with 240 °C allowed, 30 W/m (400 V). DIN IEC 60800:2009 M2, EN 62395-1:2006
DEVlasphalt™ Resistive heating mat	DEVlasphalt™ 300T 230 & 400 V program	Twin conductor, 100% screen, UV stabilized, black, short term contact with 240 °C allowed, 300 W/m <sup>2</sup> (230 V/400 V). DIN IEC 60800:2009 M2, EN 62395-1:2006
Fixing	DEVIfast™ Metal DEVlclip™ C-C Montagestege™ 6 mm Montagestege™ 8 mm	25 m pack; galvanized metal, fixings every 2,5 cm. 10 x 1 m; plastic, fixes cable Ø every 1 cm. 1 m; plastic, fixes cable Ø 5,6-6,5 mm every 2,5 cm. 1 m; plastic, fixes cable Ø 6,6-8 mm every 2,5 cm
Fixing	DEVlclip™ Twist	Bag with 1000 pcs.; Ø 17 mm; fixing cable to reinforced mesh
DEVlreg™ Regulator	DEVlreg™ 850	Connection to Ground and Roof moisture and temp. sensor, max 4 sensors, 2 zones, 2x15 A, PSU 24 V, DIN rail
Moisture & temperature sensor	Ground sensor for DEVlreg™ 850	Ø93 x 98 mm, IP67, 15 m connection cable 4x1 mm <sup>2</sup>
Accessories	PSU 24 V for DEVlreg™ 850	Extra PSU for DEVlreg™ 850 with 3-4 sensors
DEVlreg™ Thermostat	DEVlreg™ 330 (5...45 °C)	5...45 °C, 16 A, IP20, with 3 m wire sensor, DIN rail
DEVlreg™ Thermostat	DEVlreg™ 610	-30...+50 °C, 10 A, IP44, with 3 m wire sensor, on wall/pipe installation
DEVlreg™ Room thermostat	DEVlreg™ 130	5...45 °C, 16 A, IP30, with 3 m wire sensor, room on wall installation
Temperature sensor	10 m, PVC	Wire sensor, Ø8 mm, IP65, NTC 15 kOhm @25 °C

For additional information please refer to the DEVI Catalogue.

# 4. System Design

The following paragraphs contain estimations according to ASHRAE, Application Handbook and Historical Weather Data.

Figures are for reference only and can vary depending on the area size, wind speed and ground construction.

For more information about performance of different ice and snow melting systems, as well as control, see Outdoor Application manuals.

When installing ice and snow melting systems it may be necessary to provide drainage for melted water at the slope bottom, walkways, etc. The drain system should also be protected against ice formations.

## 4.1 Output

The heat required for snow melting depends on the following main factors:

- Weather conditions (min. temperature, max. snowfall rate, wind speed, humidity, altitude);
- Project details (materials, foundation type, dimensions, insulation);
- Electrical data (voltage, power, control requirements);
- System performance expectations;
- Safety factor.

Evaluation of the specific output for ice and snow melting systems can be done based on the diagram and other similar documents.

For example, heat loss depending on the wind speed and temperature differences between the surface and the ambient air is described in 2003 ASHRAE Application Handbook (see fig. 3).

For example, for medium weather conditions and 6 m/s wind speed, if choosing  $\Delta T = 10$  K (from -3 K to +7 K) the heat loss value is approx. 230 W/m<sup>2</sup> (marked with the red dotted line in fig. 3).

In other words, surface heating up to 10 degrees requires 230 W/m<sup>2</sup> or  $230 / 10 = 23$  W/(m<sup>2</sup>·K).

All in all, for medium winter weather conditions, heating of 1 m<sup>2</sup> outdoor surface up to 1°C needs power of approx. 23 Watts. Or the calculation heat exchange coefficient for outdoor surfaces is approx. 23 W/(m<sup>2</sup>·K) (sometimes named  $\alpha_{out}$  – “alpha out”).

As an example IEC 62395-2 provides another evaluation of typical snow melting heat loads (see table 1).

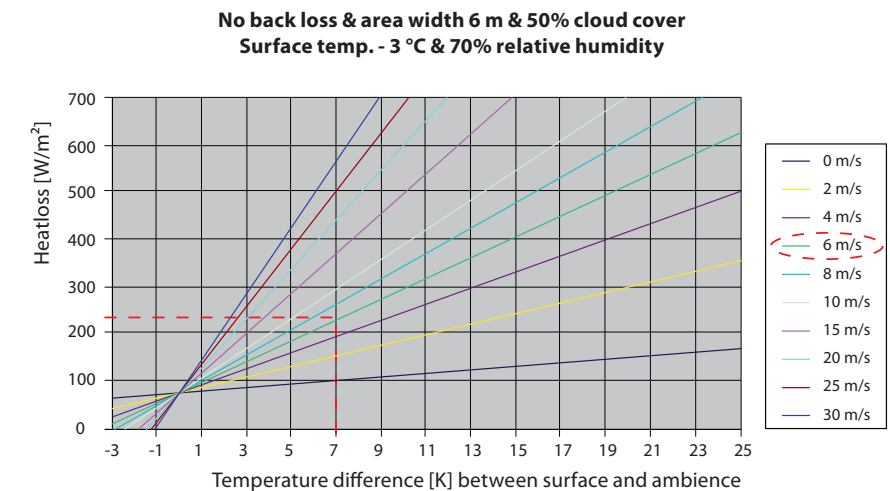

Fig. 3. Wind and temperature dependent heat loss

Weather severity	Application criticality		
	Minimum, for example, residential walkways and driveways	Moderate, for example, commercial walkways and driveways	Maximum, for example, tall plazas, hospital emergency entrances and helicopter decks
	W/m <sup>2</sup>		
Mild	150 to 250	250 to 350	300 to 400
Severe	200 to 300	300 to 400	350 to 500
Very severe	250 to 350	400 to 550	450 to 750

Table 1. IEC62395-2. Typical snow melting heat loads

Values in table 1 less than 250 W/m<sup>2</sup> should be used in limited circumstances, for example in countries with a warm climate or based on the technical justification. Low output at the level of 150-200 W/m<sup>2</sup> may be insufficient for snow and ice melting.

For ice and snow melting systems it is recommended the following simple rule for output selection:

- minimum – 250 W/m<sup>2</sup>,
- optimum – 350 W/m<sup>2</sup>.

Output for ice and snow melting systems should be designed in compliance with applicable local norms and regulations.

Add 100 W/m<sup>2</sup> in the following cases:

- local winter design temperature is lower than -15 °C;
- for every 1000 m altitude;
- if the heated area is a free standing construction without insulation;
- if the local average wind speed is >6 m/s;
- if the more efficient system is required;
- if it snows at temperatures lower than -10 °C.

**Note.** It is recommended to design output for ice and snow melting systems with maximum possible level.

The recommended heat density values depend on the local climatic conditions and are shown in a table below.

Design temperature, °C	City, e.g.	Recommended heat density, W/m <sup>2</sup>	Maintenable air-surface ΔT, °C
-5	London	250	11
-15	Vienna, Beijing	350	15
-25	Oslo, Kyiv	400	17
-35	Moscow	500	21

### Minimum melting temperature

The main task of ice and snow melting systems is melting, i.e. to maintain +3 °C on the surface. Any output can be addressed to the lowest temperature at which ice or snow is still melting and a heating system provides its main task. Table 2 shows some heat output (W/m<sup>2</sup>) and temperature values at which the system ensures ice & snow melting or, in other words, provides constant +3 °C on the surface.

Output, W/m <sup>2</sup>	Min air temperature for +3 °C on surface (α <sub>out</sub> = 23 W/(m <sup>2</sup> ·K))
250	-8 °C
300	-10 °C
350	-12 °C
400	-14 °C
550	-21 °C

Table 2. Minimum melting air temperatures for some outputs. ΔT surface-air is calculated as output divided by the heat exchange coefficient 23 W/(m<sup>2</sup>·K).

For example, if 250 W/m<sup>2</sup> is installed, then the heating system enables ice and snow melting at the air temperature not lower than -8 °C (ΔT = 250/23 ≈ 11 °C).

But if the ambient/air temperature is -12 °C for instance, then the surface temperature will be -1 °C, with ΔT = -11 °C for output of 250 W/m<sup>2</sup>. It means that the system consumes power to heat the surface, but doesn't melt ice or snow at all.

## 4.2 Installation method for Ground applications

### 4.2.1 Heating cable/mat embedded in concrete

Heating cable/mat placed on concrete or sand/grit basement.

- It is recommended to place the cable min at 5 cm depth from the surface if installed in concrete. Concrete thickness has to be chosen according to the local norms and regulations.
- Make sure that the mat/cable is fastened to the basement as concrete might cause displacement of the cable when poured.
- The concrete mixture must not contain sharp stones which may damage the cable.

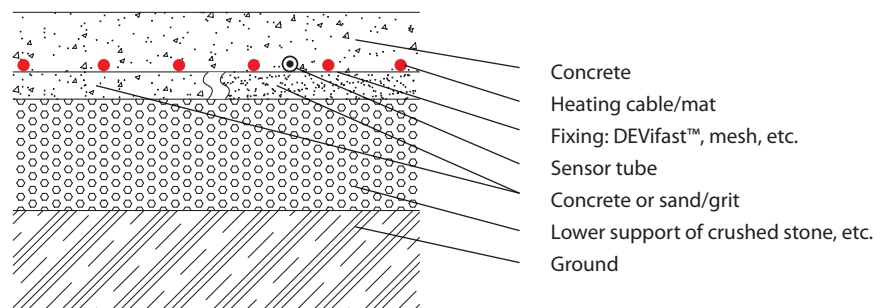

- Concrete needs 30 days to harden before operation of the heating cables.

### 4.2.2 Heating cable/mat with bricks/concrete tiles surface

Heating cable/mat placed into sand or sand mixture.

- Special care must be taken to avoid damage of the heating cable when installed under bricks/tiles.
- The area must be completely levelled and free of stones or other sharp objects.
- The heating cable/mat must be installed closely to the bricks/tiles, typically in a sand layer (at least 2,5 cm under the brick/tile).

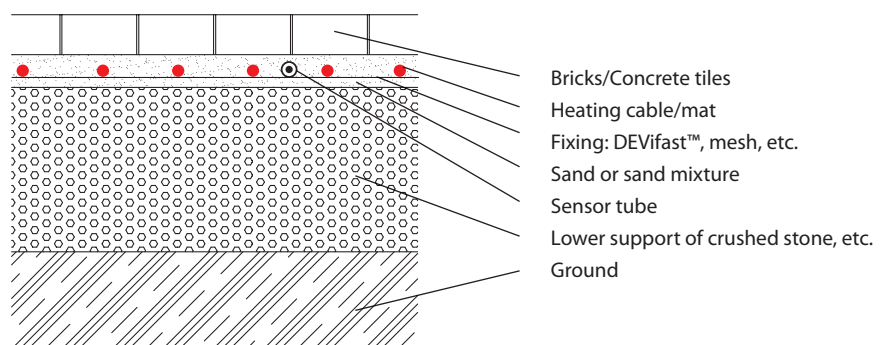

### 4.2.3 Heating cable/mat with asphalt surface

Heating cable/mat placed into protection layer. For information about asphalt cable/mat installation please refer to the "Asphalt application. Ice & Snow Melting" Application manual.

- The cables must be covered with sand or concrete (at least 2,5 cm) prior to applying asphalt to protect them from the asphalt heat.
- Allow asphalt to cool down to 130...140 °C.
- It is strictly prohibited to apply asphalt directly onto the standard cable/mat.
- Asphalt minimum thickness should comply with local norms and regulations.

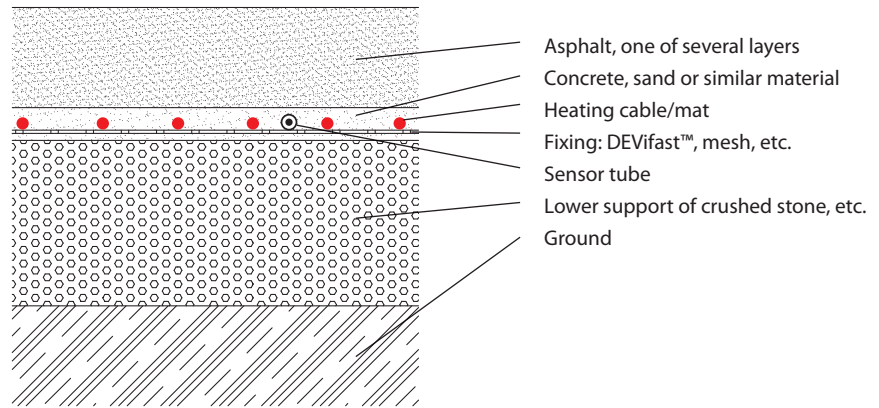

### 4.2.4 Heating cable/mat with a thermal insulation layer

Heating cable/mat placed on a thermal insulation into concrete protection layer.

- It is strictly prohibited to install heating cable/mat directly on a thermal insulating material.
- When a thermal insulation layer is applied the concrete protection layer should be provided.
- When laying a heating cable, special care must be taken to avoid its penetration of the thermal insulating material.

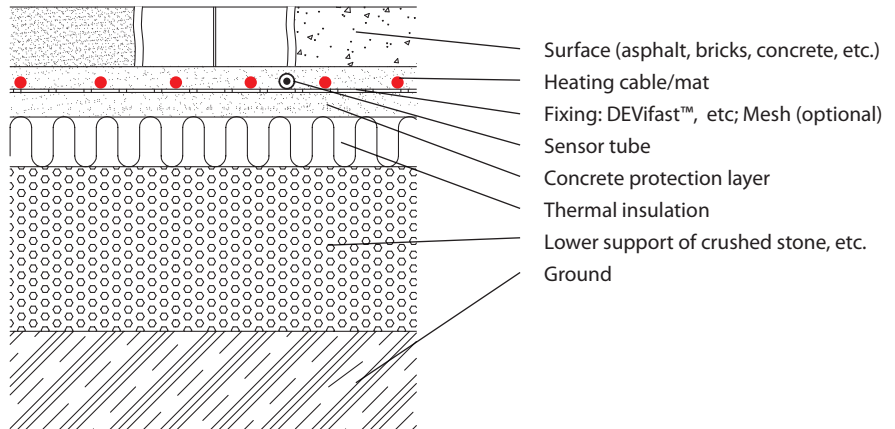

## 4.3 Insulation

The benefit of thermal insulation is significant for free standing constructions such as ramps or bridges, steps, etc. Insulation of the free sides of the construction must also be considered.

For example, a 6 m wide bridge is exposed to snow at -3 °C air temperature and 4,5 m/s crossing wind. Calculated approx. downward heat losses are presented in the table below.

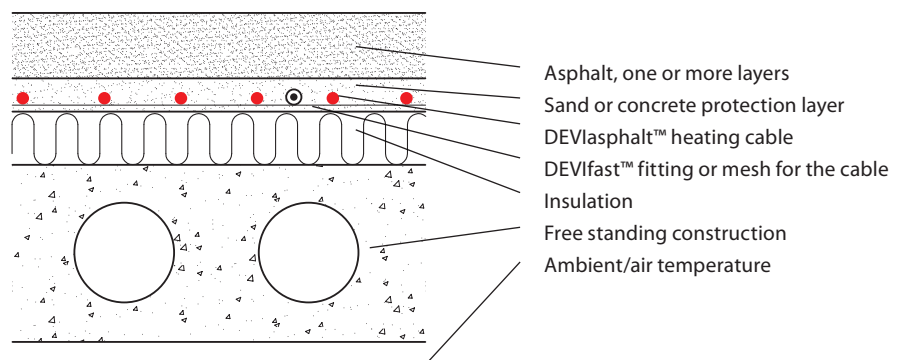

Insulation thickness	Downward heat loss, %
No insulation	36
20 mm	23
50 mm	15
100 mm	9

## 4.4 C-C distance and corresponding output (W/m<sup>2</sup>)

The C-C distance is a centre-to-centre distance between adjacent cables (sometimes named "installation step").

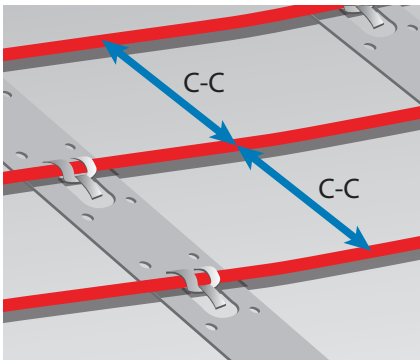

**Note!** Heating cable bending diameter must be at least 6 times cable diameter.

The C-C distance and corresponding output W/m<sup>2</sup> can be calculated by formulas – see Appendix.

Outputs for some cables with various C-C distances for Ice and Snow Melting Systems on the Ground are presented in the table:

C-C distance, cm	Heat density, W/m <sup>2</sup> (230/400 V)		
	DEVIflex™ 18T 18 W/m	DEVbasic™ 20S, DEVIsafe™ 20T 20 W/m	DEVIsnow™ 30T, DEVIsphalt™ 30T 30 W/m
5	360	400	600
7,5	240	270	400
10	-	-	300
12,5	-	-	240

## 4.5 Control

Ice and snow melting systems are different and require different thermostat types. The product range of controls is designed for ground outdoor systems including the following:

- thermostats with a temperature sensor – DEVIreg™ 330 (5...45 °C), DEVIreg™ 610;
- regulator with integrated temperature and moisture sensors – DEVIreg™ 850.

To control simple or low output systems – approx. up to 5 kW – thermostat with a wire temperature sensor is recommended.

To control systems with up to 10 kW output a regulator/controller with temperature and moisture sensors is recommended. This solution should be used for any smaller installations where optimum power is a priority.

The wire temperature sensor is usually installed in a conduit pipe nearby the heating cable ("in the ground"). DEVIreg™ 330 (5...45 °C) thermostat with the DIN rail attachment is recommended as a standard solution. It can be also used a wall/pipe mounted DEVIreg™ 610, IP44.

As an option, to control small areas nearby private houses, etc., wall mounted room thermostat DEVIreg™ 130

can be used. Please pay attention to the right place for the thermostat installation, considering that this is an IP20 room thermostat.

To control ice and snow melting systems DEVIreg™ 850 regulator/controller with an integrated temperature and moisture sensor is recommended at the optimum power. We recommend this regulator for installations with output exceeding 10 kW or for any smaller installations where optimum power is a priority.

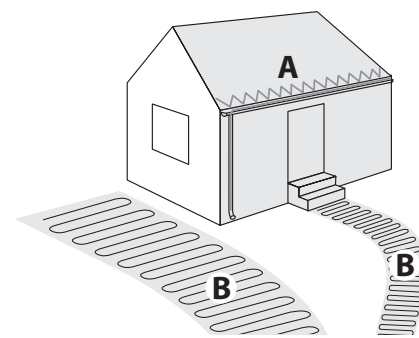

The ground sensor is equipped with a 15 m cable for connection to a regulator. The cable length can be adjusted in accordance with the Installation Instruction.

Comparing to installations with typical ground temperature measuring this regulator allows reducing energy consumption costs of up to 40%.

### Temperature adjustment.

The temperature sensor is mounted below the surface near the heating cable, where it is "warmer" than on the surface. This enables system adjustment to the desired temperature: for each 1 cm below the surface it should be adjusted to about +1,5 °C or approx. 1,5 °C/cm.

For example, if the sensor is installed under the pavement of 10 cm thickness, temperature adjustment should be: 1,5 °C/cm · 10 cm = 15 °C. Taking into account the required +3 °C at the surface, the thermostat should be set to 15 °C + 3 °C = 18 °C. Therefore, the use of DEVIreg™ 330 with temperature range -10... +10 °C is not recommended since it is impossible to set temperature over +10 °C.

### Running costs

The running costs are largely influenced by how the system is controlled. DEVIreg™ 850 is a more efficient solution since a moisture sensor enables its switching to a standby mode during dry periods.

Thermostat	Sensor type	Running cost index
DEVIreg™ 850	Ground temperature and moisture	1
DEVIreg™ 330	Ground temperature (e.g. +3 °C)	1,2-1,4
Reference	Air temperature	2-5

## 4.6 Design

The system is usually designed taking the available power supply into account. If the available power supply is limited, then:

- Reduce the area to be heated, e.g. by heating tire tracks instead of the whole driveway.
- Divide and prioritize the area in 2 zones by means of DEVIreg™ 850 or e.g. 2 DEVIreg™ 330 (5...45 °C).
- Install minimum recommended  $W/m^2$ , knowing that the snow melting performance is reduced.
- Do not install less  $W/m^2$  than recommended in areas of drainage e.g. in front of heated steps.

If the snow melting system is undersized, e.g. due to power limitations, the system will respond slower and less efficiently. A higher temperature level compensates this, but causes higher running costs.

If the snow melting system is oversized, the system will respond faster and more efficiently. To lower the standby temperature and running costs, DEVIreg™ 850 can be used.

### Example 1. Walkway with pavement blocks

An ice and snow melting system is required to melt snow from a 2 x 10 m walkway with pavement blocks on sand. Power supply voltage is 400 V. Heating mats can be selected due to their simple installation.

Heating mats output is  $300 W/m^2$  (near optimum output level – see 4.1).

Total output:  $300 \cdot (2 \cdot 10) = 6000 W$ .

Two mats DEVIsnow™ 300T 400 V (1 m width) can be chosen:  $4250 W$  (1x14,8 m) +  $1770 W$  (1x6 m) =  $6020 W$  (24,8  $m^2$ ).

Optionally, heating cable DEVIsnow™ 30T 400 V with C-C = 10 cm ( $300 W/m^2$ ) can be chosen: either  $5770 W$  (190 m, 19  $m^2$ ) or  $6470 W$  (215 m, 21,5  $m^2$ ).

When thermostat DEVIreg™ 330 (5...45 °C) with a sensor cable placed in the ground is chosen, DEVIreg™ 850 with two ground sensors can be selected as an option.

### Example 2. Driveway near garage of a private house

Data: driveway dimensions – 10 m length, 2 m width; surface thickness – 6 cm; power supply – 230 V; restriction of power for electricity connection.

Due to restriction of power supply it should be recommended installation of a heating cable in two tire tracks instead of the whole driveway. Width of tire track is 0,5 m.

**1. Cable selection.** For this system it can be used for instance a two-conductor DEVIflex™ 18T (see chapter 3). To comply with the recommended in 4.1 output of  $350 W/m^2$  it should be chosen C-C = 5 cm that gives specific output of  $360 W/m^2$  (see Appendix A.1).

**2. Calculation of the cable installation area:**  
 $10 m \cdot 0,5 m \cdot 2 \text{ track} = 10 m^2$ .

**3. Calculation of the total system power:**  
 $10 m^2 \cdot 360 W/m^2 = 3600 W$ .

**4. Selection of cable power/ length.** Cable DEVIflex™ 18T with  $3600 W$  output does not exist (see DEVI Catalogue), so you should apply two cables with total capacity of about  $3600 W$ , i.e. cables with the output:  $3600 / 2 = 1800 W$ . This output can be ensured by for instance DEVIflex™ 18T – 90 m,  $1625 W$ , 2 pcs. The total output of two cables will be  $3250 W$  that is a bit less than the calculated value, and for C-C = 5 cm the heating area is approx.  $9 m^2$ . Alternatively you can select two DEVIflex™ 18T – 105 m,  $1880 W$  with total output –  $3760 W$ .

**Note.** If the driveway near the garage has a tray for water drainage, it is necessary to install at least two lines of cable along the drainage and its length should be taken into account when choosing the cable.

**5. Length of fixing tape.** The cable can be attached by e.g. DEVIfast™. Installation step is typically 50 cm and the length is defined as the heating area multiplied by 2 that is  $10 m^2 \cdot 2 = 20 m$  of DEVIfast™.

**6. Thermostat selection.** Since the system output is small – less than recommended 10 kW (see 4.3), you can choose “simple” DEVIreg™ 330 (5... 45 °C) with a wire temperature sensor, which is installed in the ground. An appropriate connection scheme should be chosen – with or without contactor. The output of two 90 m cables is  $3250 W$  that enables their connection to one DEVIreg™ 330 of max  $3680 W$ , therefore an additional contactor is not required. The output of two 105 m cables is  $3760 W$  that disables their connection to one DEVIreg™ 330, therefore an additional contactor is required.

**7. Calculation of thermostat temperature settings** (see 4.3). The installation depth of a wire temperature sensor is 6 cm and in order to maintain the surface temperature of +3 °C the following value should be set:  
 $1,5 °C/cm \cdot 6 cm + 3 °C = 12 °C$ .

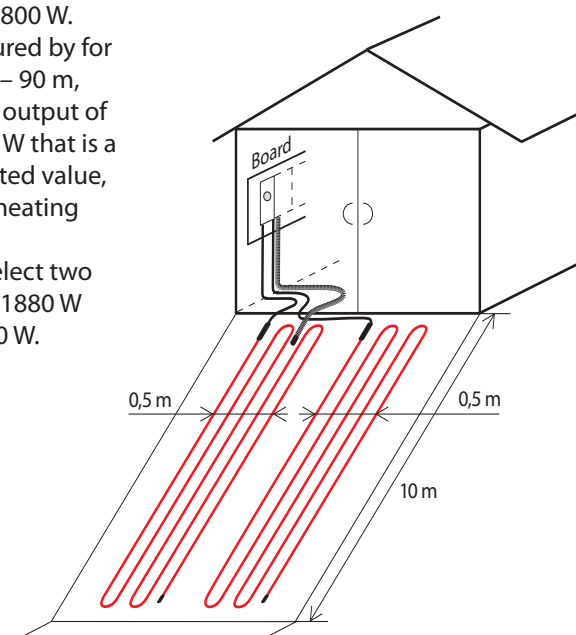

# 5. Installation

## 5.1 General safety instructions

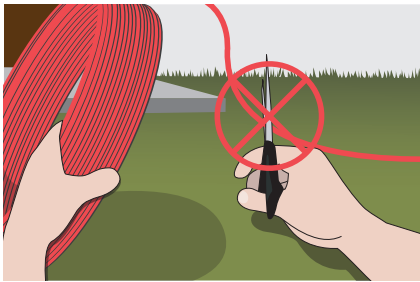

### Never cut or shorten the heating element.

- Cutting the heating element will void the warranty.
- Cold leads can be shortened to suit requirements.

Elements must always be installed according to local building regulations and wiring rules as well as the guidelines in proper installation instructions and this manual.

- Any other installation may hamper element functionality or constitute a safety risk, and will void the warranty.
- Make sure that elements, cold leads, connection boxes, and other electrical components do not come into contact with chemicals or flammable materials during or after installation.



### Elements must always be connected by an authorized electrician using a fixed connection.

- De-energize all power circuits before installation and service.
- The connection to the power source must not be directly accessible to the end user.
- Each heating cable screen must be earthed in accordance with local electricity regulations and connected to a residual current device (RCD).
- Recommended RCD trip rating is 30 mA, but may be up to 300 mA where capacitive leakage may lead to nuisance tripping.
- Heating elements must be connected via a switch providing all pole disconnection.
- The element must be equipped with a correctly sized fuse or circuit breaker, e.g. 10/13 A for a 1,5 mm<sup>2</sup> cold lead and 16/20 A for a 2,5 mm<sup>2</sup> cold lead.

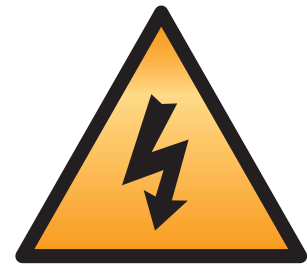

The presence of a heating element must

- be made evident by affixing caution signs or markings at the power connection fittings and/or frequently along the circuit line where clearly visible
- be stated in any electrical documentation following the installation.

Never exceed the maximum heat density (W/m<sup>2</sup> or W/m) for the actual application.

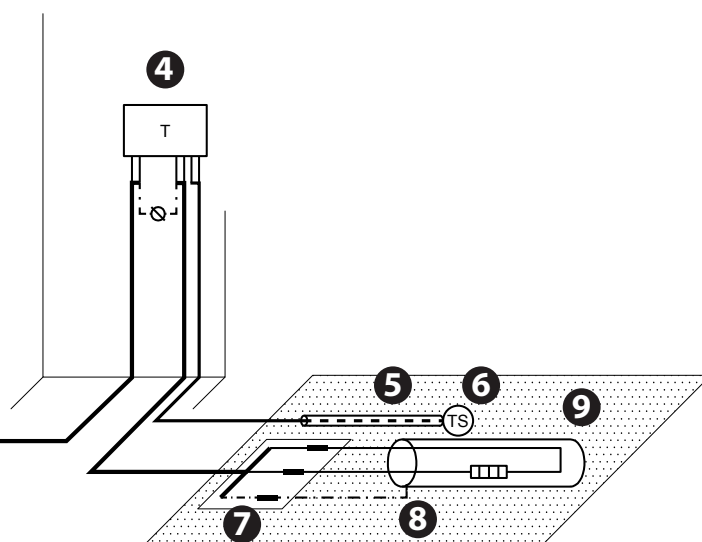
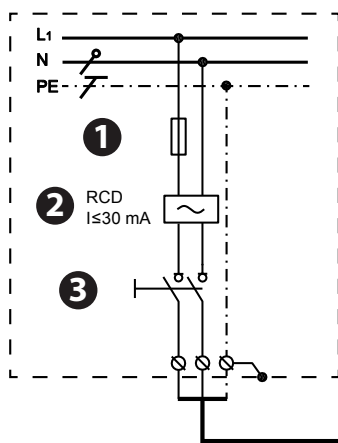

1. Fuse
2. RCD
3. All-pole switch
4. Thermostat
5. Conduit pipe
6. Sensor
7. Connection muff
8. Cable screen
9. Heating cable

### 5.1.1 When making installation:



Prepare the installation site properly by removing sharp objects, dirt, etc.

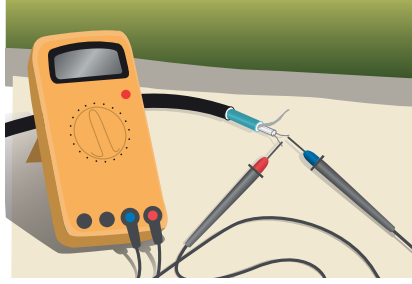

Regularly measure Ohm resistance and insulation resistance, minimum: before, during and after installation.

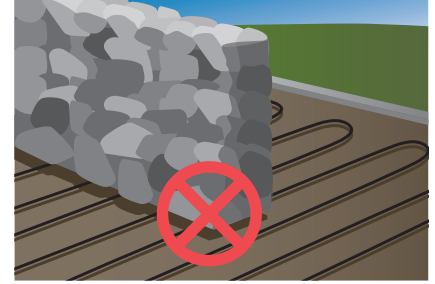

Do not install heating elements under walls and fixed obstacles. Min. 6 cm space is required. Keep elements clear of insulation material, other heating sources and expansion joints.



Heating elements may not touch or cross themselves or other heating elements and must be evenly distributed on areas.



The elements and especially the connection must be protected from stress and strain.



The element should be temperature controlled and not operate at ambient temperature higher than 10 °C in outdoor applications.

### 5.1.2 Planning the installation

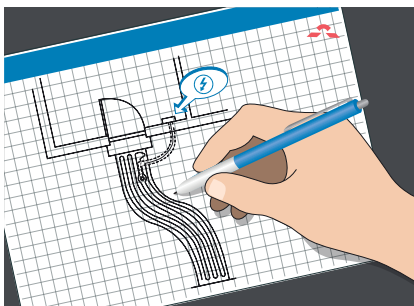

#### Draw a sketch of the installation showing

- element layout
- cold leads and connections
- junction box/cable well (if applicable)
- sensor
- connection box
- thermostat/regulator

#### Save the sketch

- Knowing the exact location of these components makes subsequent troubleshooting and repair of faulty elements easier.

#### Please observe the following:

- Observe all safety guidelines.
- Observe correct cable C-C distance and distance between mats.
- Observe required installation depth and possible mechanical protection of cold leads according to local regulations.
- When installing more than one heating element, never wire elements in series but route all cold leads in parallel to the connection box.
- For single conductor cables, both cold leads must be connected to the connection box.



## 5.2 Installation

### 5.2.1 Preparing the installation area



Remove all traces of old installations, if applicable.

- Ensure that the installation surface is even, stable, smooth, dry and clean.
- If necessary, fill out gaps around pipes, drains and walls.
- There must be no sharp edges, dirt or foreign objects.

### 5.2.2 Installing heating elements

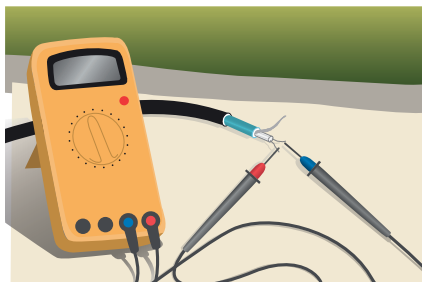

It is not recommended to install heating elements at temperatures below -5 °C.

At low temperatures, heating cables can become rigid. Connect the cable/mat to the mains for a short time (few minutes). The cable or mat must be rolled out during this process!

#### Measuring resistance

Measure, verify and record element resistance during installation.

- After unpacking.
- After fastening the elements.
- After the installation is finalized.

If Ohm resistance and insulation resistance are not as on label attached to product and product transportation box, the element must be replaced.

- The ohmic resistance must be within -5 to +10 % of the value labeled.
- The insulation resistance should read >20 MΩ after one minute at min. 500 V DC.

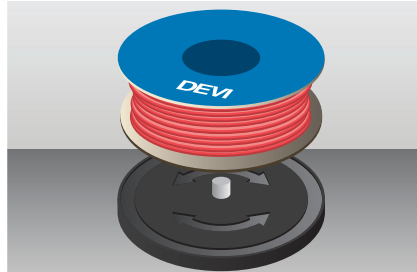

Observe all instructions and guidelines in section about general safety and in proper installation instructions.

#### Heating elements

- Position the heating element so that it is at least half the C-C distance from obstacles.
- Heating elements must always be in good contact with the heat distributor (e.g. concrete).
- When using heating mats secure them to the ground, some mats are mitted with a glue covered surface, it attaches well to a cleaned and primed surface.

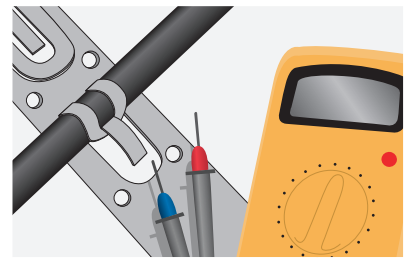

#### Heating mats

- Always roll out heating mats with the heating cables facing up.
- When the heating mat reaches the area boundary, cut the liner/net and turn the mat before rolling it back.

#### Extending cold leads

- Avoid extending cold leads if possible. Wire cold leads to e.g. junction boxes or cable wells.
- Be aware of power loss in the extending cold leads according to local regulations and wiring rules.

### 6.2.3 Installation summary

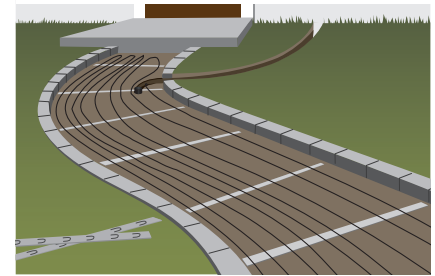

Prepare installation surface with fastening accessories and/or mesh reinforcement.

Apply sensor conduit Ø 16-20 mm. Fix conduit for sensor tube for DEVIreg™ 850 ground sensor, if any.

Place cold leads and connections in a dry place. Seal all penetrations through walls or similar structures. Apply caution tape above cold leads.

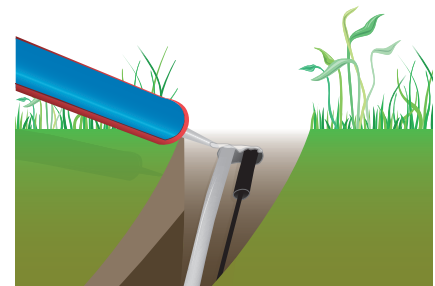

After laying blocks or pouring concrete/asphalt, install external sensor(s), and extend sensor cable(s) according to the sensor manual.

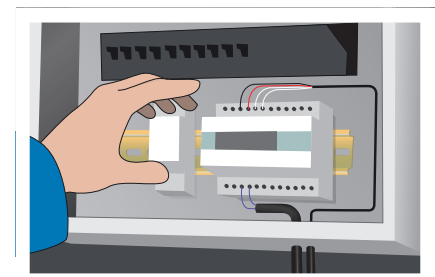

The DEVIreg™ thermostat/regulator must be commissioned as prescribed in the installation manual and adjusted where local conditions vary in relation to factory settings.

Before every season, check for faults in the switchboard, thermostat and sensors.

## 5.3 Precautions

Ensure to clean the area properly from stone and sharp edges.



Protect the heating cables against excessive use of rakes, shovels, vibrators and rollers.



Do not tip the wheel barrow by supporting it directly on the cables.

Fasten the cables to the sub-construction in short distances to ensure that the cable remains in right position.

It is recommended to connect a buzzer or other alarm giving device to the cables if an incident anyway should occur during installation despite all caution and a cable is being damaged. Then there will be the ability to quickly detect this and get the problem solved at the lowest possible cost and delay.

Ensure that all cables turn towards the electrical cupboards where the cables shall be connected.

Remember that the cable always shall be fully embedded to avoid air gaps.



For second layer of asphalt should be used drum/roller with the maximum limited load of 500 kg.

It is not allowed to drive directly on the cables with heavy trucks or asphalt machinery, as the cable construction is developed only for a maximum mechanical load of 2000 N. It will immediately lead to cable damages.



### 5.3.1 Important

All electrical connections must be done by authorized persons according to local regulations.

**When extending cold lead, observe:**

- That there is max. 5% loss of potential power in the whole length of the cold cable.
- That the leak current of the whole installation is less than 1/3 of the RCD trigger level.

Thermostat controlling ground temperature is mandatory.

# 6. Appendixes

## A.1. C-C distance and corresponding output W/m<sup>2</sup>

The C-C distance is a centre-to-centre distance between the cables (sometimes named installation step or Cable-to-Cable distance).

When heating cables are installed, we recommend the use of DEVIfast™ fitting bands. These bands are designed to ensure a C-C distance at regular intervals of 2,5 cm, e.g. 5 cm, 7,5 cm, 10 cm, 12,5 cm, etc.

Two different formulas may be used to calculate the C-C distance:

1) Using heating cable length

$$C - C \text{ [cm]} = \frac{\text{Heated floor space [m}^2\text{]} \cdot 100 \text{ [cm/m]}}{\text{Cable length [m]}} \cdot 100 \text{ cm.}$$

2) Using cable specific output and output per m<sup>2</sup>:

$$C - C \text{ [cm]} = \frac{\text{Cable specific output [W/m]} \cdot 100 \text{ [cm/m]}}{\text{Output per m}^2 \text{ heated floor space [W/m}^2\text{]}}$$

### Example 1

For a renovation we choose a DEVIflex™ 10T cable (specific output is 10 W/m). If the chosen output is 120 W/m<sup>2</sup>, the calculated by formula no. 2 C-C distance is:

$$C - C = \frac{10 \text{ W/m} \cdot 100 \text{ cm/m}}{20 \text{ W/m}^2} = 10,35 \text{ cm.}$$

### Example 2

The DEVIflex™ 18T, 535 W, 29 m is to be installed in a bathroom with heated floor space of 3 m<sup>2</sup>.

The calculated by formula no. 1 C-C distance is:

$$C - C = \frac{3 \text{ m}^2 \cdot 100 \text{ cm/m}}{29 \text{ m}} \cdot 100 \text{ cm} = 10,35 \text{ cm.}$$

If we use DEVIfast™ fitting bands with regular intervals of 2,5 cm, we can install the heating cable in this bathroom with a C-C 10 cm.

C-C distances and corresponding outputs per m<sup>2</sup> for some linear outputs of heating cables.

C-C distance, cm	Thermal output of heating surface for several DEVI heating cables at 230* or 400* V, W/m <sup>2</sup> ,					
	6 W/m DEVIflex™ 6T	10 W/m DEVIflex™ 10T, DEVlcomfort™ 10T, DEVlbasic™ 10S	18 W/m DEVIflex™ 18T	20 W/m DEVIflex™ 20T, DEVlbasic™ 20S	30 W/m DEVIsnow™ 30T, DEVlaspalt™ 30T	
5	120	200	360	400	600	Recommended for Ice and snow melting and Frost protection systems
7,5	80	133	240	270	400	
10	60	100	180	200	300	
12,5	48	80	144	160	240	
15	40	67	120	133	200	Recommended for Comfort floor or Direct heating systems
17,5	34	57	103	114	170	
20	30	50	90	100	150	
22,5	26	45	80	89	133	Surface heating, etc.
25	24	41	72	80	120	
Usually used for Direct floor heating						

\* The outputs at 220 or 380 V has to be recalculated with the coefficient of 0,91.

## A.2. Fitting

If we want to calculate the length of fitting band (e.g. DEVIfast™, DEVIClip™ CC, Montagestege™), first of all we should determine the distance between the fitting bands.

For concrete installation, where cable is covered with 3 cm concrete or more, and the C-C distance exceeds 10 cm, the recommended distance between fitting bands is 0,5 m.

For thin constructions where cable is covered with 1-2 cm of self-leveling compound and the C-C distance is 10 cm or less, the max. recommended distance between fitting bands is 25 cm.

Below is a calculation formula for C-C distance.

$$\begin{aligned} \text{Length of fitting band [m]} &= \\ &= \frac{\text{Heated floor space [m}^2\text{]}}{\text{Distance between fitting bands [m]}} + L_w \text{ [m]} \end{aligned}$$

$L_w$  is the length of the wall parallel to fitting bands installation.

### Example

The heated floor space is  $1 \text{ m} \times 2 \text{ m} = 2 \text{ m}^2$ .

If we install DEVIfast™ fitting bands in parallel to a 1 m wall (see fig. 1) and the distance between the DEVIfast™ fitting bands is 0,5 m, a fitting band with the following length is required:

$$\frac{2 \text{ m}^2}{0,5 \text{ m}} + 1 \text{ m} = 5 \text{ m}.$$

If we install DEVIfast™ fitting bands in parallel to a 2 m wall (see fig. 2) and the distance between the DEVIfast™ fitting bands is 0,5 m, a fitting band of the following length is needed:

$$\frac{2 \text{ m}^2}{0,5 \text{ m}} + 2 \text{ m} = 6 \text{ m}.$$

As we can see from this example, the fitting band length may vary although the area and the distance between fitting bands remain the same.

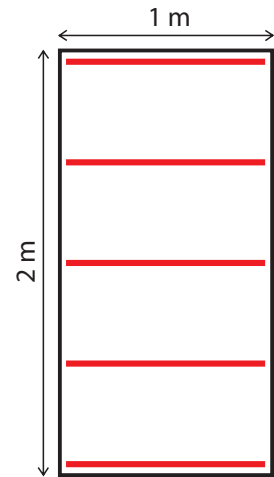

Fig. 1 - Fitting band installed in parallel to a 1 m wall.

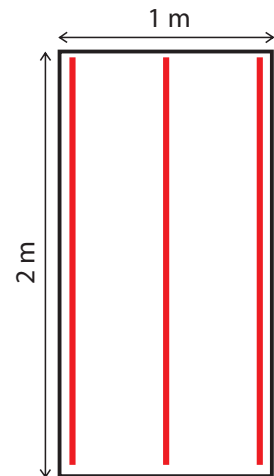
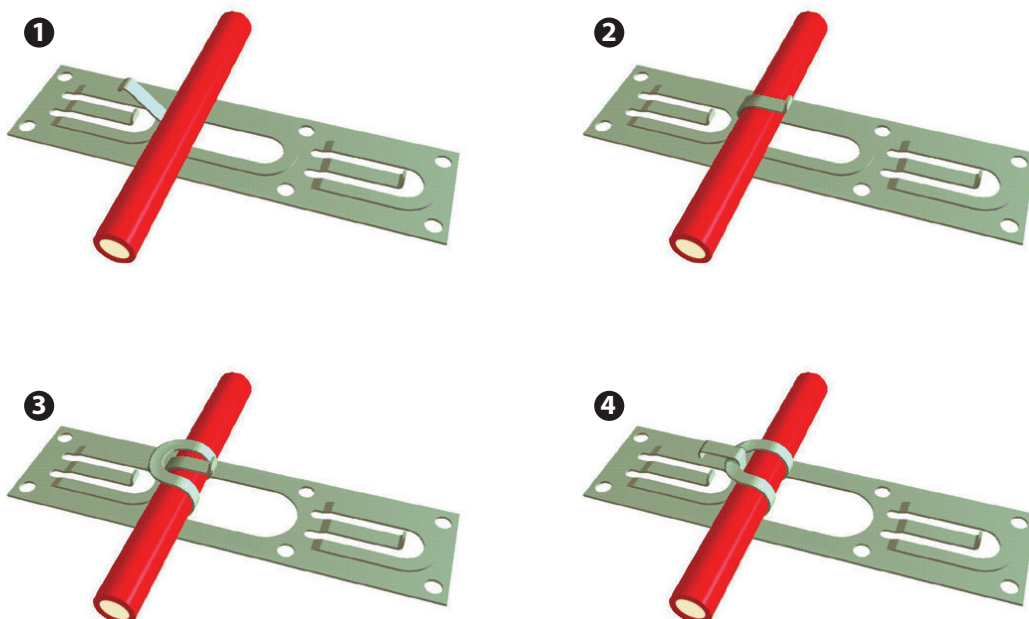

Fig. 2 - Fitting band installed in parallel to a 2 m wall.



Fixing of the heating cable on the DEVIfast™ fitting band.

### A.3. Wire sensor installation

Regardless of the system type it is always recommended install a ground wire sensor or integrated ground moisture and temperature sensor.

Before installation of the outdoor heating mat or cable, determine proper location for the connections (indoor or outdoor) and make a recession in the wall for the mounting/connection box. Cut out the wall groove from the connection box location down to the ground for connection cable (cold lead) of the heating cable and a temperature sensor conduit.

Wire sensor is usually mounted in a corrugated plastic pipe with 10-20 mm diameter. The pipe is laid in the wall groove starting from the mounting box and along the underlay to the heating area.

It must be installed within the heating cable zone, at least 0,5-1 m inside (see attached picture). The pipe should enable easy replacement of a wire sensor (remove-insert) through a hole in the mounting box.

Where the pipe is bent between the ground and the wall, the minimum bending radius is 6 cm (marked R1 in the figure). It is necessary to make a smooth bend of corrugated pipe when going from the wall to the ground.

The pipe end has to be sealed to avoid concrete penetration inside it (A mark in the figure). The pipe/sensor must be positioned in the centre of an open end of a cable loop and usually at the same level or slightly above the heating cables.

If thin heating mat is installed, conduit pipe has to be laid in a groove so it does not overhang above the surface. Groove in the ground is also required for the cold lead and muff for the same reason.

Sensor cable can be extended to any reasonable length, using a cable min. 0,75 mm<sup>2</sup>.

After the wire temperature sensor is installed it is recommended to measure resistance.

For information about installation of integrated ground moisture and temperature sensor see proper Installation Instruction.

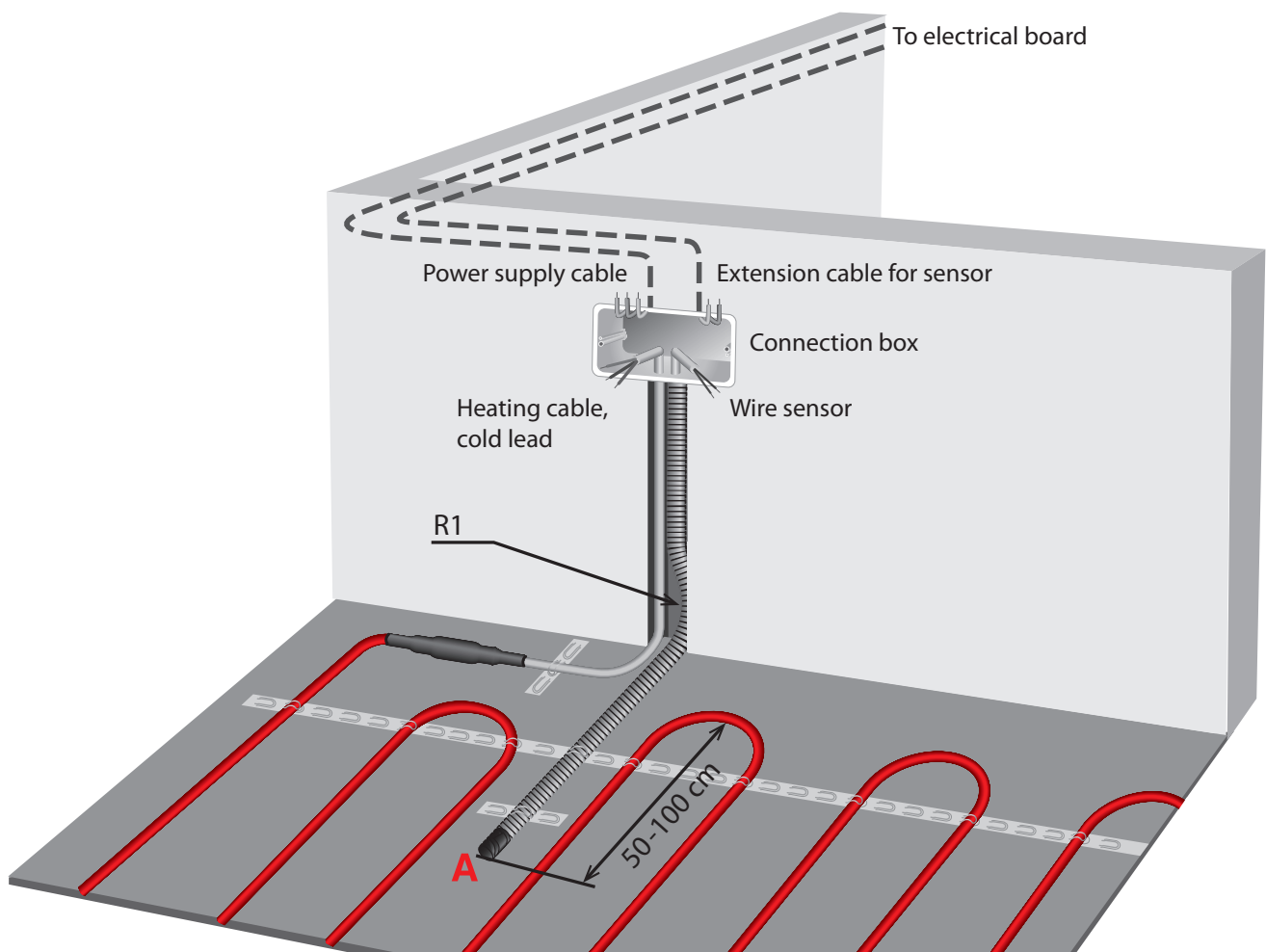

Sensor has to be installed between two heating cables and, preferably a bit above their level.

## A.4. General installation guide

The installation of heating cables and thermostats should comply with general and local regulations. The cables and the thermostats should only be connected by an authorized electrician and connected to an RCD.

It is important that the construction is well insulated according to the building standards so the downward heat loss is kept to a minimum.

Rim zone insulation, along the walls, which should be efficient in order to prevent heat from being transported to the foundation walls or adjoining rooms, and allowing for thermal expansion of the concrete.

The foundation must be clean and free of sharp objects.

The cables must never get into contact with the insulation material or become enveloped by it in any way.

The cables must be evenly spread on the available ground and led around permanently fixed objects such as bathtubs etc.

The cables must be gently attached so they are not damaged.

The concrete around the cables must not contain sharp stones and should have a consistency enabling it to surround the cable completely without leaving air pockets. The concrete should be applied very carefully in order not to damage the heating cables!

Concrete must be laid out in such a way to avoid air pocket inside it.

In connection with wet rooms (bathrooms etc.) a damp proof membrane should always be used in order to prevent moisture from entering the construction.

A damp proof membrane is needed to prevent moisture from moving upwards and into the construction.

The wire of the ground sensor must be protected by a plastic pipe.

The wire sensor must be positioned in the centre at an open end of a cable loop. Where the pipe is bent between the ground and the wall, the minimum bending radius is 6 cm.

The pipe must be sealed at the end to prevent concrete from entering. Should the cable become damaged while being laid out or later during the building process, it is a great advantage in the fault finding process to know the exact positioning of the the connection box between the heating cable and the cold cable as well the cable end, and the cable layout. It is therefore important to make a sketch showing the positioning of these things in the room.

Heating cable and wire sensors resistance needs to be measured before, during and after installation of concrete, before thermostat is connected.

The heating cable and the connection muff between the heating cable and the cold cable must both be cast in concrete. If the cable is pushed down into the insulation material or covered by it in any other way, the surface temperature may become too high, that might result in cable defects at worst.

At low temperatures (below 5 °C) the cable can become difficult to handle due to the plastic sheath. This problem can be overcome by connecting the cables for a short period. For this purpose THE CABLE MUST BE ROLLED OUT! When the cable has become flexible again, the electrical flow should be disconnected. It is not recommended to lay cables at temperatures below -5 °C.

The ground heating must not be turned on before the concrete has fully set. It takes approximately 30 days for concrete and usually

10-15 days for molding compound, tile glue etc. (it is important to comply carefully with manufacturer's recommendations).

Keep a min. 5 cm air gap beneath permanent objects and ground surface with installed heating.

Thermostat fitted with an air (room) temperature sensor should always be placed on the inner wall, away from doorway or other large openings, and not in direct sunlight.

Thermostat fitted with an air (room) temperature sensor should be placed at height above the ground of ~1,5 m (0,8-1,8 m).

To ensure an accurate and easy installation of the cables, DEVIfast™ fitting bands can be used.

The DEVIfast™ fitting bands are equipped with attachment clips at intervals of 2,5 cm so the distance between the cable loops will be 5, 7,5, 10, 12,5, 15, etc.



## 7. Cases

### ROZADOL BRATISLAVA Bratislava, Slovakia

Purpose of the DEVI system:  
Ice and snow melting on driveway in  
underground garage.

Project size:  
400 m<sup>2</sup>.

Products:

- DEVIflex™ 18T;
- DEVIreg™ 850.



### CINEPLEXX (CINEMA), Hohenems, Austria.

Purpose of the DEVI system:  
Outdoor heating of the stairs to the  
entrance.

Project size:  
89 m<sup>2</sup> area heated with 86 pcs. mats.

Products:

- DEVIsnow™ 300T, 400 V;
- DEVIreg™ 850.



Intelligent solutions  
with lasting effect

Visit [devi.com](http://devi.com)

**DEVI**®   
bv Danfoss