



Roof application. Frost protection

Application manual



Index

1. General information	4
2. System Description	5
3. Product Selection	6
4. System Design	9
5. Installation	12
6. Cases	24

Let DEVI do the work

DEVI - an abbreviation of Dansk El-Varme Industri - was established in Copenhagen, Denmark, in 1942. As from January 1st 2003 DEVI has become a part of the Danfoss Group - Denmark's largest industrial Group. Danfoss is one of the world's leading companies within heating, cooling and air-conditioning. The Danfoss Group has more than 23000 employees and serves customers in more than 100 countries.

DEVI is Europe's leading brand of electrical cable heating systems and electric pipe heating systems with over 70 years of experience. The production of heating cables takes place in France and Poland while the head office is situated in Denmark.

The value of experience

We have installed literally thousands of systems across the globe, in every conceivable setting. This experience means that we can offer you practical advice about precisely which components you need to get the best results at the lowest cost.

Roof application. Frost protection

This design guide presents DEVI's recommendations for design and installation of ice and snow melting systems for roofs application. It provides guidance for heating cable positioning, electrical data and system configurations.

Following DEVI's recommendations will ensure energy efficient, reliable and maintenance free solution for constant wattage heating cables with 20 year warranty.

Our quality management system **certifications and compliances**

✓ ISO 9001

✓ TS 16949

✓ ISO 14001

Along with full compliance with EU directives and product approvals

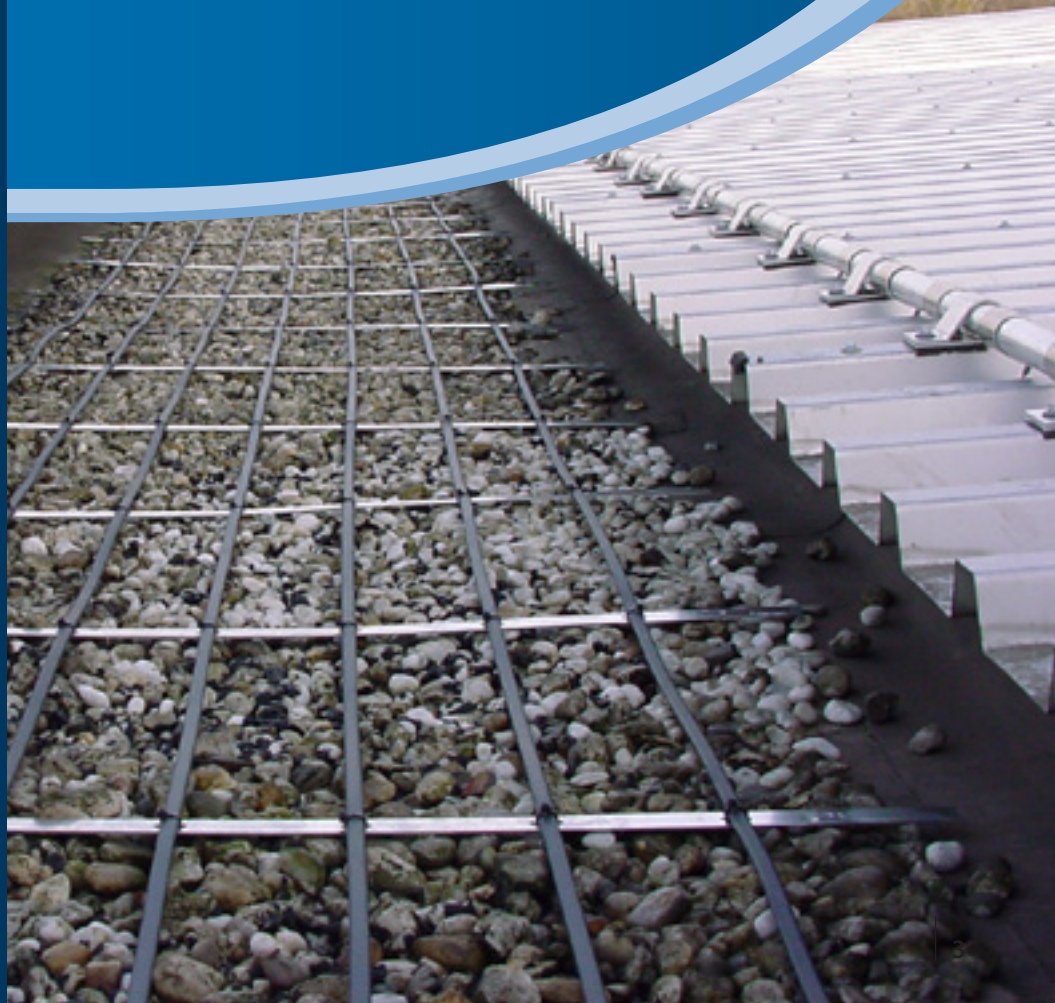

1. General information

DEVI's ice and snow melting system for roofs and roof gutters can be applied for virtually any type of roof constructions to prevent meltwater accumulation in roof gutters and to reduce damage to constructions like frozen facades and roofs.

The ice and snow melting system should be installed along the roof edge or where there is a risk of ice and snow formation. Damage prevention in roof gutters and downpipes is achieved by efficient and free meltwater draining, which typically proves satisfactory operation of the system.

Electronic DEVIreg™ thermostats ensure that optimal results are achieved with the least possible energy consumption. These results are ensured by highly precise readings of weather sensors and thermostats providing automatic on/off heating control at the right time.

The typical applications are roof constructions, roof gutters, downpipes, flat roofs and valley gutters.

Benefits

- **Enter and exit the building safely** – no risk of icicles formation or falling in cold season causing injuries or damage to vehicles or other property.
- **Relief of roof constructions** – reduces the risk of roof collapse due to extra snow loads or roof gutters and downpipes damage due to ice loads.
- **Cost reduction for renovation** following the winter season – by keeping facade walls dry as the DEVI system ensures safe water evacuation from the roof during the cold season.
- **Maintenance-free solution** with 20-year full warranty on constant wattage heating cables includes product price and all related repairing costs.
- **Cost-effective & Energy-saving solution** – designed for various weather conditions with automatic operation based on 24-h monitoring and ice and snow removal, it ensures payback period of just one snowy winter.

2. System Description

When winter sun melts snow and ice, it starts forming icicles on cold roof edges and gutters which over time can cause serious damage to the building and constitute a danger for vehicles and passerby.

First of all, in order to avoid all above and manual ice removal heating cables should be installed in all drains such as gutter valleys, gutters and downpipes.

Frost protection of the roof itself is required where such problems can exist, e.g:

- on south-faced eaves
- under skylights/roof windows
- 1-1,5 m lower the roof for older houses, e.g. with heated attics and

- on roofs where snow loads typically exceed the capacity of the existing roof construction.

In harsh water or water and sludge environment DEVIsnow™ cables provide constant wattage when appropriate, whereas DEVIceguard™ self-limiting cables represent flexible small scale installation.

Opportunities

- No winter damage costs
- Discreet UV resistant cables
- Automatic control
- Priority zones with limited power supply

Installation

DEVIsnow™ 20,
DEVIsnow™ 30,
DEVIceguard™ 18,
DEVIfast™ fitting band.

Performance

Save 50-80% with control by smart DEVIreg™ 850.

Thermostat improves DEVIceguard™ performance with regard to energy consumption.

Roof edge / Eave

DEVclip™ Roof Hook
DEVclip™ Guard Hook
DEVIfast™ & DEVIfast™ Double



Gutter
DEVclip™ Gutter
DEVIfast™

Gutter valley

DEVIfast™ & DEVIfast™ Double
DEVclip™ C-C

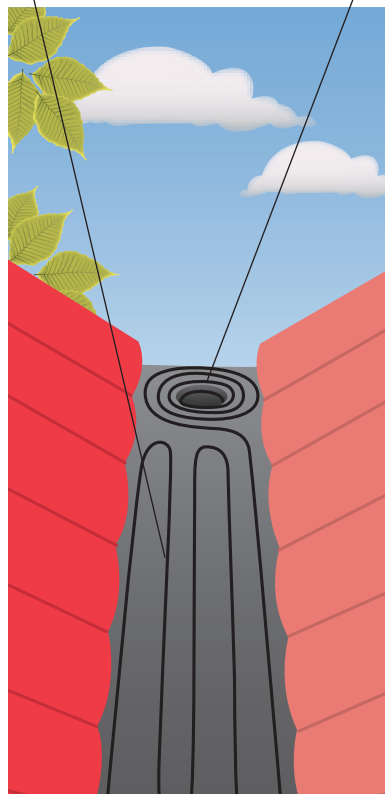

Downpipe to frost-free well
DEVclip™ Traverse
DEVIfast™ Double
Chain / Entlastungsseil

Flat roof with drain

DEVIfast™ & DEVIfast™ Double

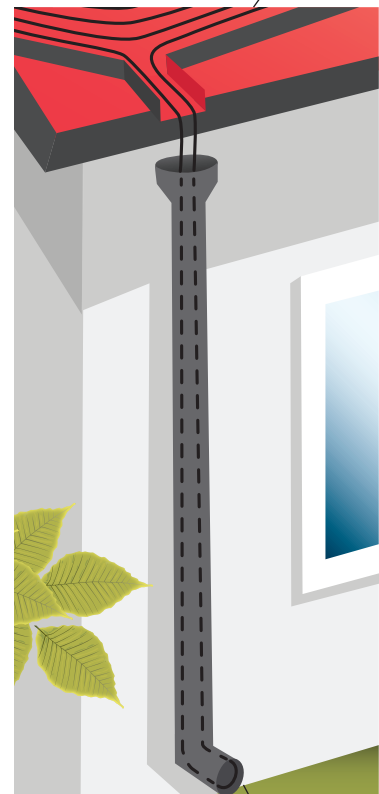

Downpipe with open end
DEVclip™ Relief
DEVIfast™ Double
Chain / Entlastungsseil

Roof with baffles

DEVIfast™ & DEVIfast™ Double
DEVclip™ C-C

3. Product Selection

3.1 Heating elements

Heating cables DEVIsafe™ 20T and DEVIsnow™ 30T:

Heating cable DEVIsafe™ 20T/DEVIsnow™ 30T – a twin conductor resistive heating cable complies with IEC 60800:2009 and provides high UV resistance. Ready-made set with a connection box and 2,5 m cold lead. Cable design provides for 230 V and 400 V power supply and ensures installation in a safe, efficient and cost-saving manner.



DEVIsafe™ 20T/DEVIsnow™ 30T

Heating cable DEVIceguard™ 18:

Heating cable DEVIceguard™ 18 is a self-limiting parallel heating cable (SLC) with high UV resistance. The cable can be cut to the required length from drum or ready made (RM) version.

The self-limiting capability of the cable ensures that the output of the cable increase or decrease according to the ambient temperature.



The heating cable is flexible and easy to install as it can be cut to length on site and can be installed directly on the roof or in the gutter system.

Important: Always install thermostat over 3 m far from the self-limiting cables, this will help to prolong cable lifetime and minimize energy consumption in a standby mode.

DEVIceguard™ 18

3.2. Control

Frost protection systems are different and require different thermostat types.

DEVlreg™ thermostats are fitted with a complete set of control functions for heating systems for ice and snow melting of any type and allow attaching external measuring sensors for air or ground temperature measuring as well as control of moisture conditions.

Electronic thermostats feature high-speed operation and good repeatability. Correctness of thermostat selection and control accuracy impact significantly on reliability and power consumption of the heating system.

The thermostat product range is designed for external systems including the following: DEVlreg™ 316, DEVlreg™ 330, DEVlreg™ 610 and DEVlreg™ 850.

DEVlreg™ 850 electronic controller

Two-zone controller is recommended for the installation protection against frost.

It has external 24 V DC power supply. Four integrated roof moisture and temperature sensors can be connected to the controller providing optimal control of the heating system. Comparing to installations with

typical temperature measuring this thermostat allows reducing energy consumption costs of up to 75% (see 3.2.1).

Moisture and temperature roof sensor

Moisture and temperature measuring sensor with a built-in heating element for snow melting. All measured values are highly accurate, which is provided by an integrated processor of the sensor as well as digital, not analogues, measurement and set-point calculation. The sensor is equipped with a 15 m cable for connection to the controller.



DEVlreg™ 850



Moisture roof sensor



DEVlreg™ 316, DEVlreg™ 610

3.2.1 DEVIreg™ 850 detailed description

DEVIreg™ 850 microprocessor controller is fully automatic, digital electronic device. Its operation is based on complex digital measurements provided by temperature and humidity measuring sensors. Simultaneous moisture and temperature measuring allows controller to save up to 75% energy comparing with systems that provide temperature measurements only.

Digital sensors provide much higher accuracy than analog ones. As a result frost protection system operated by DEVIreg™ 850 provides higher level of functionality and lower operating costs. Therefore we recommend using this type of thermostat for installations with output capacity exceeding 5 kW or for any smaller installations where optimum power use is a preference.

Configuration options

DEVIreg™ 850 can control two independent installations with maximum 4 sensors connected in various configurations, i.e. two independent systems or two zones in one system with separate outputs.

In addition, priority setting for both zones is possible. You can set one zone for the higher priority and another for the lower priority.

The zone with lower priority will be activated following switching off the zone with higher priority. In this way you can reduce demand of the available power for the frost protection system.

Intuitive menu of the thermostat allows simple settings. For detailed instructions and data specifications please refer to the safety data catalog and installation manuals for corresponding sensors and controllers.

Note: When connecting more than two sensors additional power supply is required.

Energy consumption

Control of several parameters has an effect on energy consumption.

No energy is consumed in cold dry weather – usage of moisture sensors is important and enables switching the system off in cold dry days, so no excessive energy is consumed.

Less energy consumption in case of system splitting into zones with different weather impact – splitting area into 2 zones, e.g. North and South, allows saving energy when the southern side is free of ice and snow melting runs faster by the sun heat.

Running hours for different control systems - Example from Salzburg, Austria, winter 2005/2006.

Controller	Sensor parameters	Origin of data	Hours	Index
DEVIreg™ 850	Air temperature below +3 °C and moisture	Meter reading	535	1
DEVIreg™ 316	Air temperature between +3 °C and -7 °C	Weather data	2309	4
DEVIreg™ 330	Air temperature below +3 °C	Weather data	2737	5
None	Constant from November to March		3624	7

* DEVIreg™ 850 is a highly efficient multizone thermostat which is equipped with a multilingual menu enabling both temperature and humidity measuring as well as zone prioritization in case of limited power.

3.3 Accessories

Roof and drain pipes plastic fixings, plastic tape for roof drains:

Plastic material with increased UV resistance.

Allows quick and easy installation of cables intended for heating roof areas with an installed protection system.



DEVclip™ C-C

DEVclip™ Guardhook, Roofhook, RX-C Roof Clip:

Enable non-invasive installation of heating cables in tracts and areas adjacent to roof gutter edge.

Self-limiting accessories

Refer to Installation of self-limiting cables.



DEVclip™ Roofhook, Gutter, Guardhook

Galvanized steel chain for drain pipes and DEVfast™ Double:

Corrosion-resistant hot-dip galvanized steel chain for cable installation in downpipes.

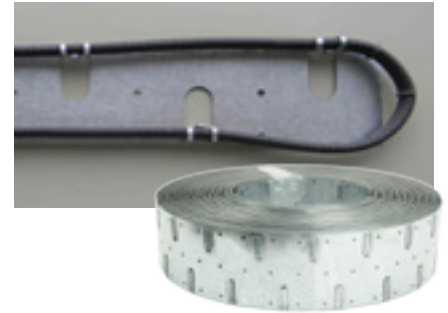

DEVfast™ Double

3.4 Product selection general overview table

Product	Options	Description
DEVIsnow™ Constant wattage	DEVIsnow™ 20T, DEVIsnow™ 30T 230 & 400 V program	Twin conductor cable, 100% screen, UV stabilized, black, DIN IEC 60800: 2009 M2
DEVIsafe™ Constant wattage	DEVIsafe™ 20T 230 & 400 V program	Twin conductor cable, 100% screen, UV stabilized, black, DIN IEC 60800: 2009 M2
DEVliceguard™ Self-limiting cable	DEVliceguard™ 18T Drum program	Twin conductor cable, wire screen, UV stabilized black DIN VDE 0254
Thermostats	DEVlreg™ 850 with air & moisture sensor DEVlreg™ 316 with min/max temp. setting DEVlreg™ 330, max. temp. setting DEVlreg™ 610, max. temp. setting	2x15 A, 24 V PSU, DIN rail -10...50 °C, 16 A, DIN rail -10...10 °C, 16 A, DIN rail -10...50 °C, 10 A, wall installation
Sensor	Roof sensor for DEVlreg™ 850 Air sensor for DEVlreg™ 316 & 330	IP67 with 15 m sensor cable IP44, 15 kΩ
Accessories	DEVlfast™ Metal	C-C steps 2,5 cm
For self-limiting cables	Connection box Connection box kit Cold tail connection kit End termination Connectors	

4. System Design

Advantages

- Keeps gutters and drain pipes free from ice and snow.
- Meltwater evacuation.
- No dangerous ice formations or snow deposits on the roof construction.
- No risk of ice/icicles or snow falling down on passerby.
- No damage to buildings and roof constructions during winter.
- DEVIreg™ 850 control allows saving up to 75% of operating power costs (comparing to DEVIreg™ 316) as the moisture sensor ensures the system switching off during dry cold days.
- Multi zones. DEVIreg™ 850 control with up to 4 sensors enables decreasing costs of the system and its installation offering at the same time better control and lower energy consumption.
- Zone priority, e.g. in case of limited power supply.

Required output

To determine the required output (W/m²) of the roof ice and snow melting system it is important to take into account the type of roof construction and local weather conditions.

Generally all roofs can be divided into two categories:

- 1. Cold roofs.** These are well-insulated roofs with low upward heat losses. Typically they are subject to ice formations during periods of snow melting under the sunlight on the roof surface.
- 2. Hot roofs.** These are not properly insulated roofs and/or buildings with habitable attics. Hot roofs provide snow melting to a certain extent followed by meltwater moving to the roof edge where it freezes up.

The rated output in gutters should therefore be higher for hot roofs than for cold ones. This will ensure proper efficiency even at low temperatures.

4.1. Roof and down pipe

For roof applications should be used cables of 20-30 W/m output. In case of cable installation on the roof top by means of meltable materials (like bitumen) the heating cable rating must not exceed 20 W/m.

Gutters running along the cold roof edge generally require 30-40 W/m. As a reference the required rating for the hot roof is 40-50 W/m. In this case in order to provide adequate output per meter, 2 or 3 DEVIsnow™ cables are

required and in some cases even more.

For further information, please refer to the table below:

Area	Cold roof	Hot roof	Max. rating	Cable rating
Valley gutter, roof surface	200-300 W/m ²	250-350 W/m ²	400 W/m ²	20-30 W/m
Downpipes, plastic roof gutters	30-60 W/m	40-60 W/m	60 W/m*	20-30 W/m
Downpipes, metal roof gutters	30-60 W/m	40-60 W/m	100 W/m*	20-30 W/m
Downpipes, wooden roof gutters	30-40 W/m	40 W/m	40 W/m	20 W/m

* We recommend 2 x 30 W/m cable lines or 3 x 20 W/m cable lines in downpipes with diameter of Ø120 mm and above.

The same as for frost protection when installing the system on flat roofs or in gutter valleys follow the ratings recommended for your geographic location (between 250 – 400 W/m²).

Down pipes

Calculation

Recommended heat density for roofs and gutters depends on local climatic conditions.

Refer to the table below to select an appropriate cable output q_{cable} applicable for both pipes (n) and areas (C-C).

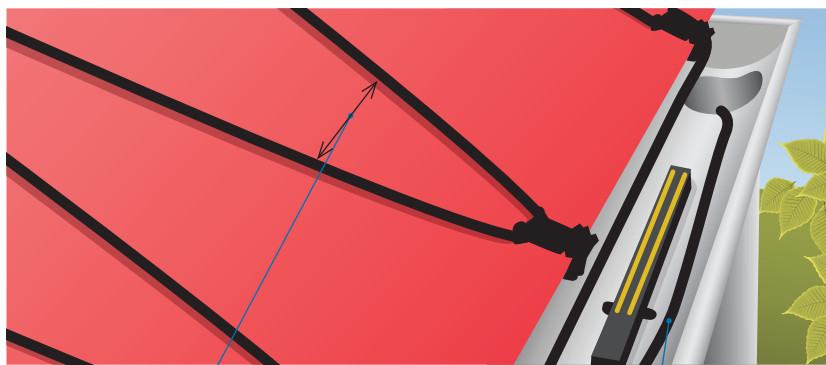

C-C – Average cable distance in cm in gutter valleys and on roof areas

n – Number of cable lines in gutters and down pipes.

Design temperature °C	City e.g.	Heat density (W/m ²)	DEVliceguard™ SLC		DEVIsnow™ resistive			
			18 W/m		20 W/m		30 W/m	
			n	C-C (cm)	n	C-C (cm)	n	C-C (cm)
0 to -5	London	250-250	1-2	8	1	9	–	–
-6 to -15	Vienna, Beijing	250-300	2	7	2	7-8	1	12
-16 to -25	Oslo, Kiev	300-350	2-3	6	2	6	2*	10
-26 to -35	Moscow	350-400	3	5	3	5	2*	8

* 2 lines of 30 W/m (60 W/m) require minimum Ø120 mm downpipe and a moisture sensitive controller e.g. DEVlreg™ 850.

Ensure that the number of cable lines n complies with the gutter/pipe diameter from the table below.

If not applicable, you can choose cables for roofs and gutters separately.

Gutter/pipe diameter	No. of cable lines, n
Ø75-120 mm	1
Ø120-150 mm	2*
Ø150-200 mm	3

Design temperature, °C	20 W/m, n	30 W/m, n
0 to -5	1	-
-6 to -15	2	1
-16 to -25	2	2*
-26 to -35	3	2*

* 2 lines of 30 W/m (60 W/m) cable require minimum Ø120 mm downpipe and a controller with a moisture sensor, e.g. DEVlreg™ 850.

$$P_{\text{cable}} \geq P_{\text{roof}} + P_{\text{gutter}}$$

$$P_{\text{roof}} = q_{\text{roof}} \cdot (A_{\text{valley}} + A_{\text{roof}})$$

$$P_{\text{gutter}} = q_{\text{cable}} \cdot n \cdot (L_{\text{gutter}} + L_{\text{pipe}}) + 0.5 \cdot C$$

P_{cable} power required by cable (see Product Sheet), W;

P_{roof} power required on roofs and gutter valleys, W;

q_{roof} heat density on roofs and gutter valleys, W/m²;

A_{valley} gutter valley area to be heated, m²;

A_{roof} roof area to be heated, m²;

P_{gutter} power required in gutters and downpipes, W;

q_{cable} cable output = 18, 20 or 30 W/m, W/m;

n number of lines in gutters and downpipes;

L_{gutter} length of gutters to be heated, m;

L_{pipe} length of down pipes to be heated + 1 m, m;

C number of Self Limiting Cable connections (0,5 m cable each).

Observe max length for DEVliceguard™ 18 (see Data Sheet or Product Catalogue)



4.1.1 Example

Example from Oslo (design temperature -21°C)

3,5 m² roof tiles, 5 m gutter and 3 m Ø120 mm downpipe to frost-free depth (+1 m) needs frost protection.

Since roofing is tiled, all cable types can be used. DEVIsnow™ 30T is preferred.

According to the calculation table above, the roof heat loss is:

$q_{\text{roof}} = 300 \text{ W/m}^2$ which means that 2 cable lines should be used in the gutter and downpipe.

The power required is now found by:

$$P_{\text{roof}} = 300 \cdot 3,5 = 1050 \text{ W.}$$

$$P_{\text{gutter}} = 2 \cdot (5+3+1) \cdot 30 = 540 \text{ W,}$$

$$P_{\text{roof}} + P_{\text{gutter}} = 1050 + 540 = 1590 \text{ W.}$$

From the DEVIsnow™ 30T product sheet 1700 W, 55 m cable is chosen.

C-C on roof = 9,5 cm.

Optionally a C-C distance of 10 cm is chosen, and the 2 m cable left is fixed to an unheated area.

As a controller the moisture sensitive DEVireg™ 850 is chosen, since it is required with 2 lines of DEVIsnow™ 30T in a Ø120 mm downpipe.

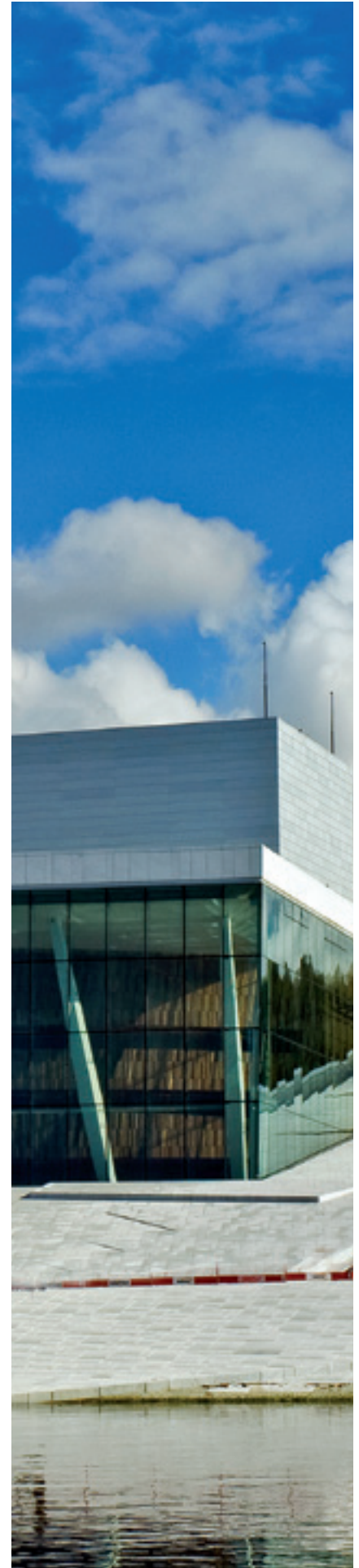
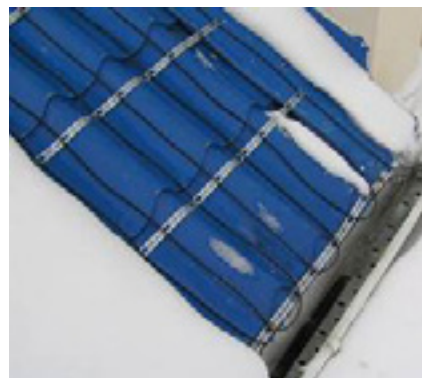

5. Installation

For the roof installation it is recommended to use DEVIsafe™, DEVIceguard™ 18 or DEVIsnow™ cables due to their increased UV resistance. The cable must be laid along the gutter in both directions to provide required thermal power.

Usually two lines of heating cable are sufficient. The exact number of cable lines (n) to ensure proper heating in gutters and downpipes depends mainly on two factors:

- design temperature,
- diameter of the gutter/downpipe.

The tables on p. 10 list the recommended amount of heating cable sections in typical gutters and downpipes, according to the above parameter.

Installations in downpipes made with self-limiting heating cables DEVIceguard™ doesn't require the use of metal chain. However the cable must be protected against cuts that can occur, e.g. on the sharp edges of the metal down pipes.

To do this, a set for mounting of self-limiting cables Spaceclip is used, to protect cables at the transition from the gutter into the drain pipe.

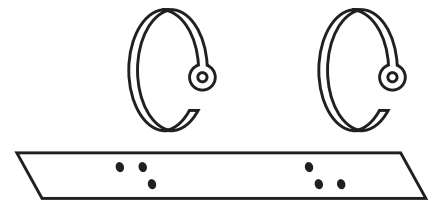

For controlling the roof gutter installation, it is recommended to use DEVIreg™ 850 combined with gutter sensor (integrated temperature and moisture sensor). DEVIreg™ 316 with air temperature measure, can also be used.

5.1. Safety Instructions/precautions

5.1.1. Roof gutter and down pipe

Heating cable installation in gutter and drain pipe

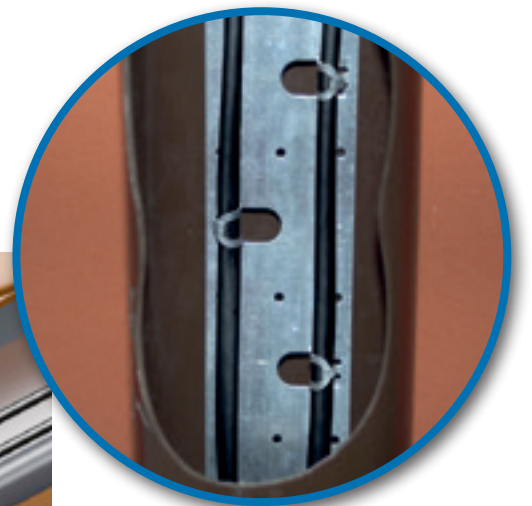
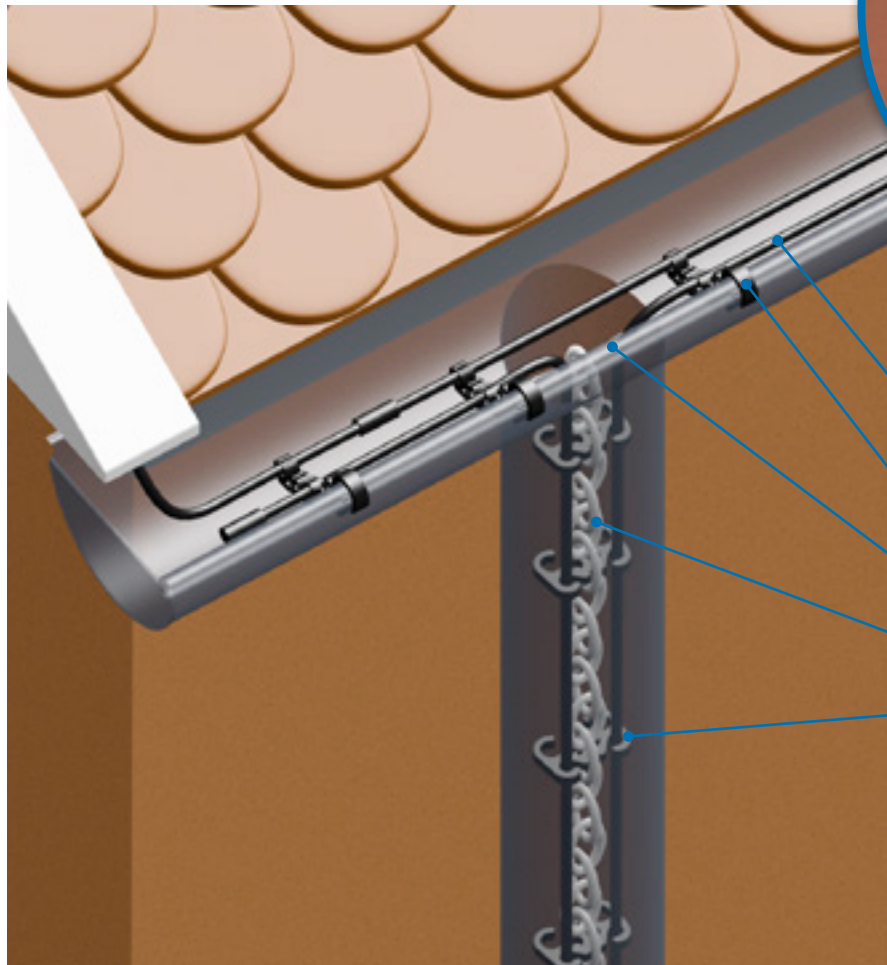

- DEVIfast™ Double
- DEVIsnow™ 20T or DEVIsnow™ 30T heating cable*
- Plastic gutter clip DEVIClip™ Gutter
- Steel bar Spaceclip
- Metal chain DEVIchain™
- Plastic drain pipes clip DEVIdrain

* For drain pipes with diameter 120 mm or more, two lines of 30 W/m heating cable should be placed. For diameters to 120 mm two lines of 20 W/m heating cable will be enough.

Installation in gutter, heating cable and sensor placing

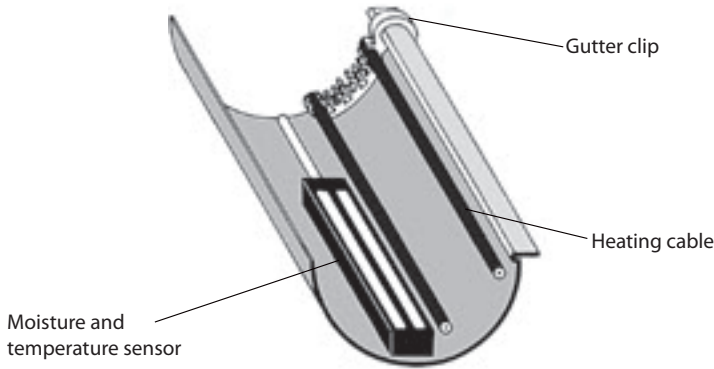

The heating system will be placed in a standard plastic gutter length 37,5 m combined with two drainpipes, with a length of 15 m each. These pipes enter the system sewerage placed approx. 1 m beneath the ground surface.

Example. Frost protection system in roof gutter and down pipe

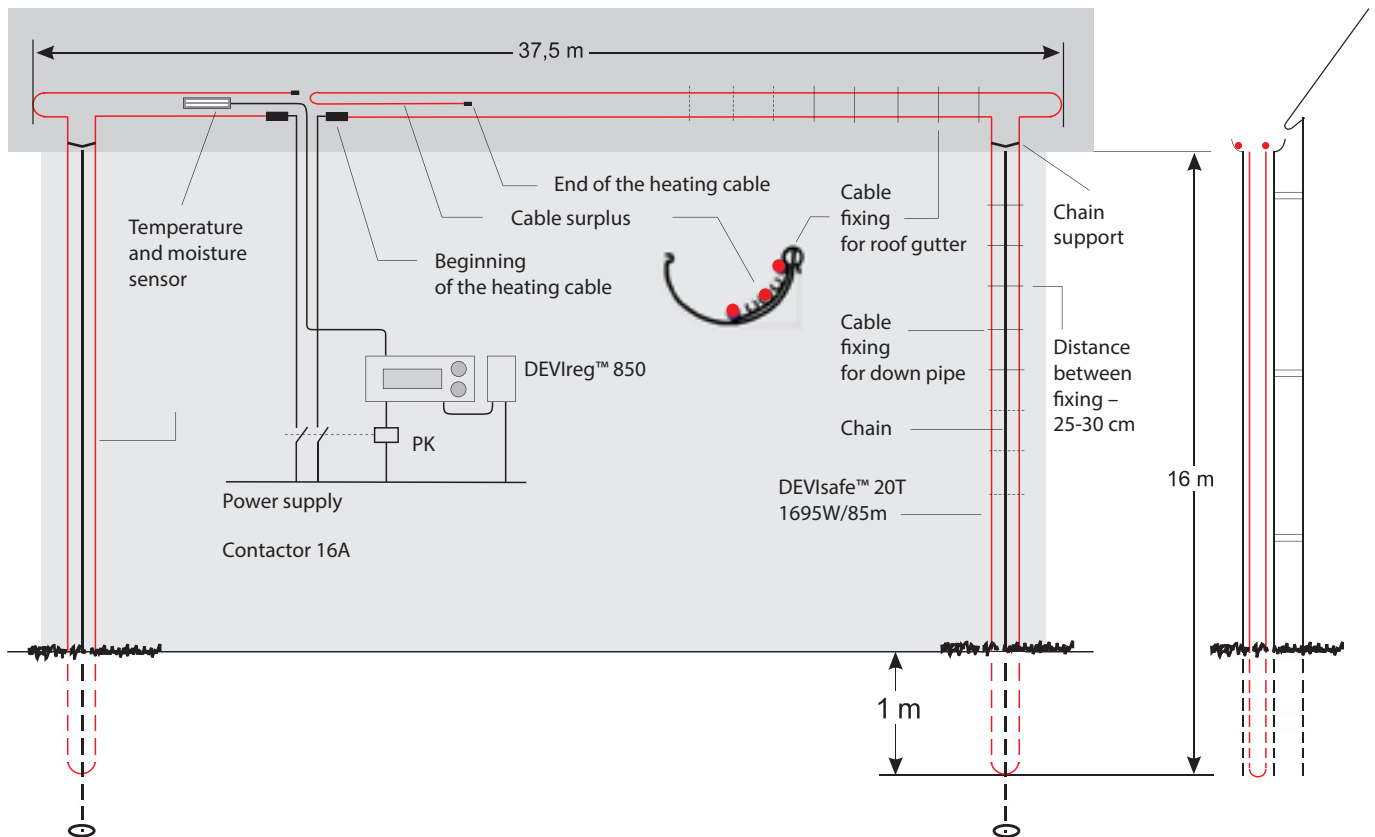

1. Required cable length:

$2 \cdot (37,5 \text{ m} + 2 \cdot (15 \text{ m} + 1 \text{ m})) = 139 \text{ m}$.
In the calculation following was taken into account:
necessity to extend the heating system in downpipes, to make water frost protection in drainpipe and under ground.

2. Choice of heating cable:

We choose two heating cables: DEVI-safe™ 20T with a length of 85 m and an output of 1695 W and DEVI-safe™ 20T with a length of 60 m and an output of 1200 W. (See DEVI catalogue)

The cables will be arranged, as shown below, in the gutter and downpipe in the form of two parallel sections which will provide 40 W/m output.

Surplus cable: $85 \text{ m} + 60 \text{ m} = 145 \text{ m} - 139 \text{ m} = 6 \text{ m}$
is placed in the middle part of clip hook between the cables already installed in the gutter. In order to keep the cables in the right position, roof gutter clips (DEVIclip™ Gutter) should be mounted at approx. 25-30 cm intervals. The cable in the downpipe must be fixed by some extra chain.

5.1.1 Gutter valley and drain pipe

The installation of heating cables in valley gutters typically concerns larger buildings. The heating cable is led backwards and forwards along the gutter so the correct output per m² is achieved, see table in 4.1.

We recommend DEVIfast™ fitting bands to fasten the cable in the valley gutter and DEVIchain™ plastic cable holders to attach the cable to the metal chain in the downpipe.

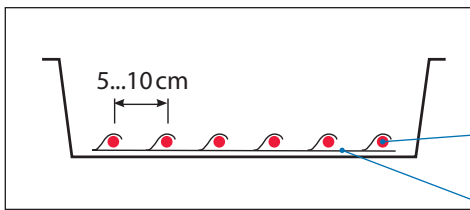

The DEVIfast™ is fixed by means of hotmelt, silicone, etc., but the best decision would be by screws or rivets.

Typically downpipes are connected to roof drains to ensure adequate water evacuation. Even if there is no need to protect downpipe

along its full length, e.g. in case of installation in continuously heated building, arrangement of a 1 m cable loop is required. Otherwise a standard installation method by means of chain and fixing accessories should be used along the full length of the drain pipe.

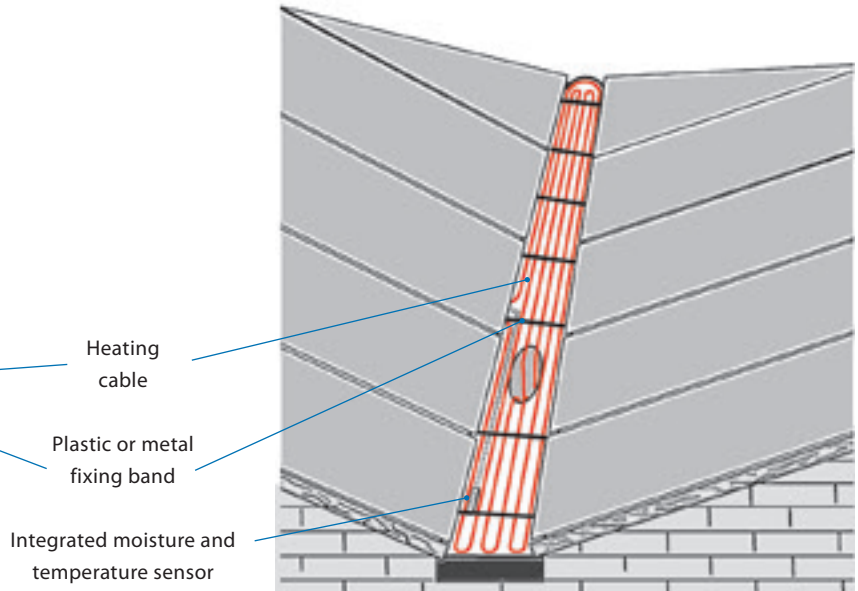

Gutter valley heating cable installation

Example

The frost protection heating system will be placed in the gutter valley of 0,5 m x 11m connected to 4 m drain pipe.

Select DEVIsnow™ 30T cable assuming that the necessary output is 300 W/m² (C-C = 10 cm).

1. The heated area is:
 $11 \text{ m} \cdot 0,5 \text{ m} = 5,5 \text{ m}^2$.
2. The total installed capacity of the roof drain:
 $300 \text{ W/m}^2 \cdot 5,5 \text{ m}^2 = 1650 \text{ W}$.

The installed output in the gutter valley of 150 mm diameter:
 $2 \cdot 4 \text{ m} \cdot 30 \text{ W/m} = 240 \text{ W}$.

Total installed heating power:
 $1650 + 240 = 1890 \text{ W}$.

3. Find an appropriate position in the product list for DEVIsnow™ 30T heating cables. The item with 2060 W output and 70 m length meets our requirements.

4. C-C distance:

$$C-C = \frac{5,5 \text{ m}^2 \cdot 100 \text{ cm/m}}{70 \text{ m} - 8 \text{ m}} = 9 \text{ cm}$$

To fix cables in the roof drain use DEVIfast™ fitting bands (C-C = 10 cm) or plastic installation tapes, downpipe chains and appropriate fixing clips.

5. To control the installation select DEVIreg™ 850 controller with integrated moisture and temperature sensor.

Note. Two lines of DEVIsnow™ 30T (30 W/m) can be used in drain pipes with diameter of 120 mm or more.

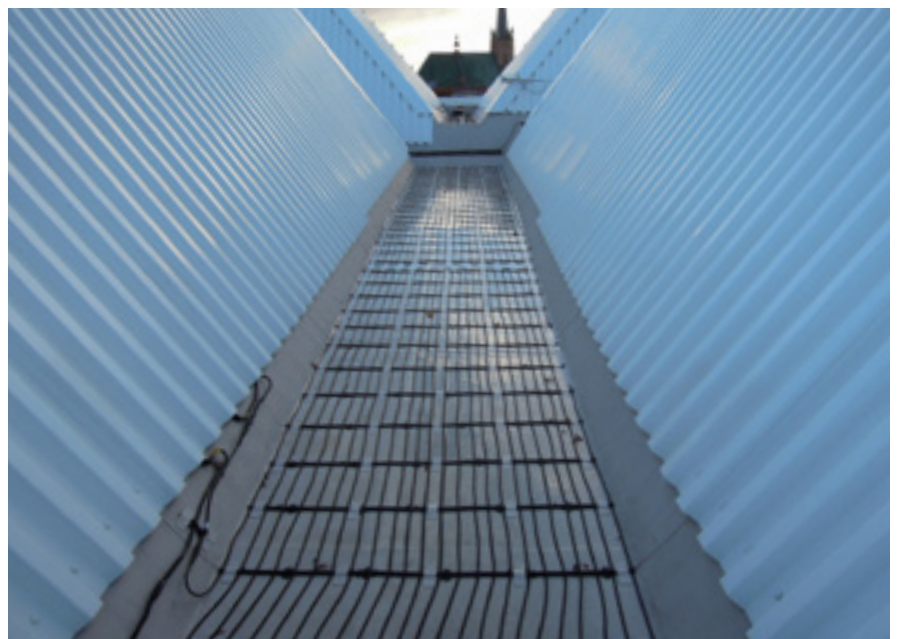

5.1.2 Roof edges

Often lower unheated parts of roofs (especially hot roofs) are subject to accumulation of large amount of snow and ice. This will slowly transform into large and heavy overhang.

During thaw periods it may break down leading nearly always to gutter destruction and contributing serious danger for passerby.

To prevent overhang formation lower parts of the roof should be equipped with a heating system. Usually the roof heating system uses special fencing (as shown in the picture) to avoid snow slides.

Example

The installation will be laid on the "cold" (well insulated) roof of 8 m length. The installed output of the roof surface is 300 W/m² according to weather conditions.

The cable will be laid in loops covering area of 50 cm in direction from the roof edge.

1. Heated area:
 $8 \text{ m} \cdot 0,5 \text{ m} = 4 \text{ m}^2$.

This snow fence is typically installed at a distance of 50 cm from the roof edge at the same level with upper ends of the heating cables.

The cable must be arranged in a loop running up and down and covering area of about 50 cm in direction from the roof edge (refer to the picture below).

Quick installation and durable cable assembly is deemed to be properly secured when using DEVIclip™ Guardhook, a dedicated fixing for this kind of installations.

2. Installation total power:

$$4 \text{ m}^2 \times 300 \text{ W/m}^2 = 1200 \text{ W.}$$

3. Select DEVIsnow™ 30T cable with 40 m length and 1250 W output. (See DEVI Catalogue)

4. C-C distance between lines of the cable is calculated with help of:

$$C-C = \frac{4 \text{ m}^2 \cdot 100 \text{ cm/m}}{40 \text{ m}} = 10 \text{ cm.}$$



5. The selected cable should work as integrated part of an installation in the gutter and drain pipe, so connect it to the same control, e.g. DEVIreg™ 850.

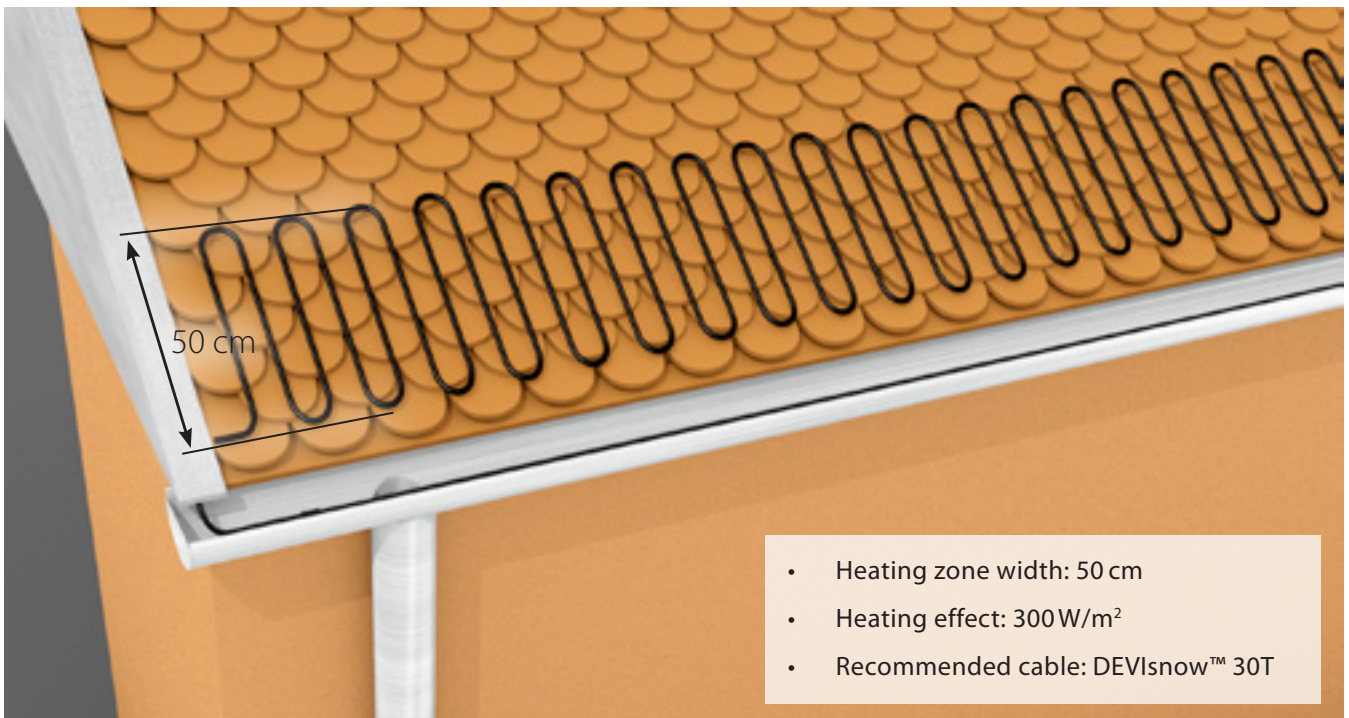

Roof edges and gutter with heating installation.

5.1.3 Flat roofs & internal roof drains

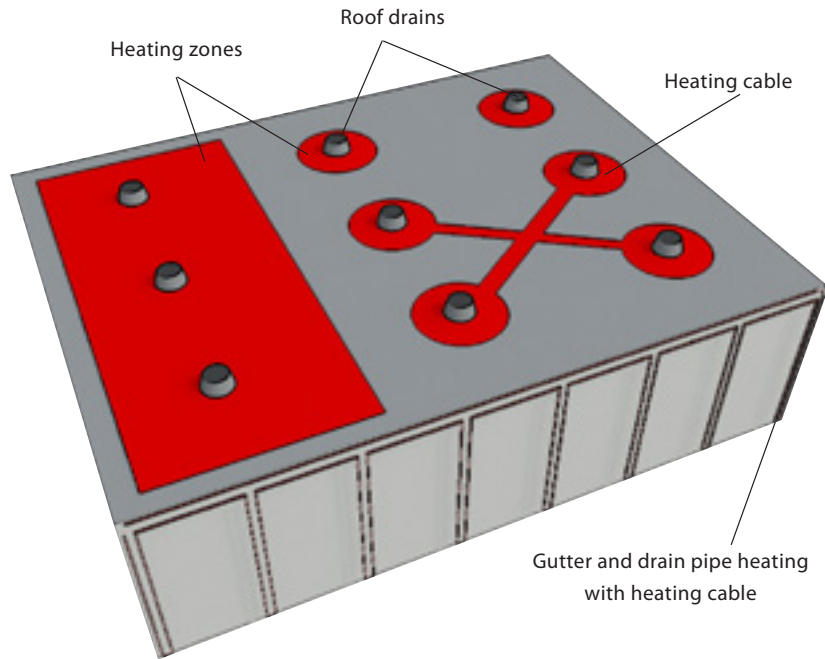

When planning frost protection on flat roofs, protection of the following building elements should be taken into account:

- gutters and downspouts (downpipes) located along the roof edge (1). These elements are protected according to principles described in section of this Application manual about Gutters and downpipes heating;
- internal roof drains (2) which can be protected by short pieces of heating cables laid spirally around the inlet (see picture below).
- roof cavity and grooves between internal roof drains (3). Use a separate set of heating cables for each groove or a set of heating cables for connection of several grooves or inlets at once. To provide route between grooves use min. 2-3 length of DEVI safe™ 20T, DEVI snow™ 30T, or DEVI iceguard™ 18 self-limiting heating cable;

- protection of flat roof areas (4). This is the most effective way to protect the roof against snow, however it requires larger installation in terms of heating output than any described above.

Recommended surface efficiency for this type of installation is 350-400 W/m² for roofs covered with sheet metal and 250-300 W/m² for roofs covered with bitumen sheet or similar materials.

Note: If you use DEVI snow™ 30T cable on the roofs covered with bitumen sheet or similar materials, please consult DEVI's technical service.

Internal roof drains.

Implementation of the heating cable helps to avoid snow or ice formation around the drain and ensure free water evacuation.

Recommended heating power: 250-300 W/m² output density per 1 m² for each drain.
E.g. DEVI safe™ 20T, DEVI snow™ 30T heating cable or DEVI iceguard™ 18 self-limiting heating cable.

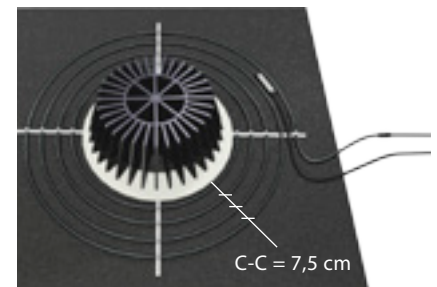
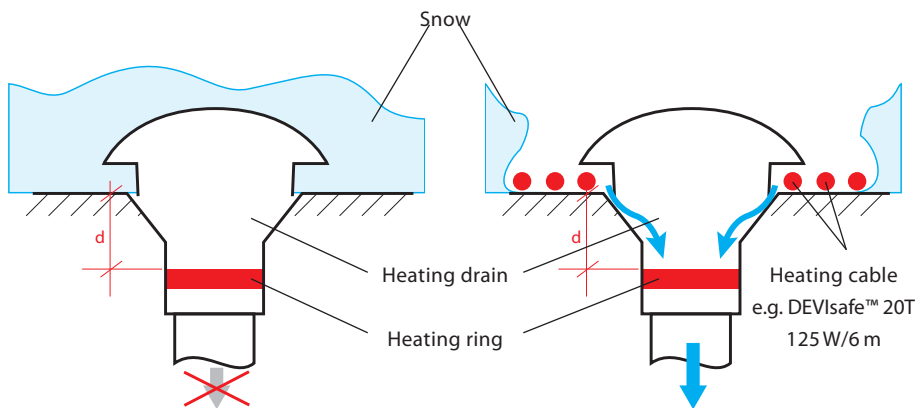

DEVI safe™ 20T/30T heating cable or DEVI iceguard™ 18 with same length

During heavy snowfalls heating ring which is used in the heated roof drains will not fulfill its function due

to overlong distance from the roof plane.

Frost protection system for flat roofs calculations examples

Assumptions:

- Roof dimension: 40 m x 20 m
- 9 roof drains
- No roof gutters and downpipes

Example 1

Heating of only drain inlets.

Installed power: $9 \times 125 \text{ W} = 1125 \text{ W}$

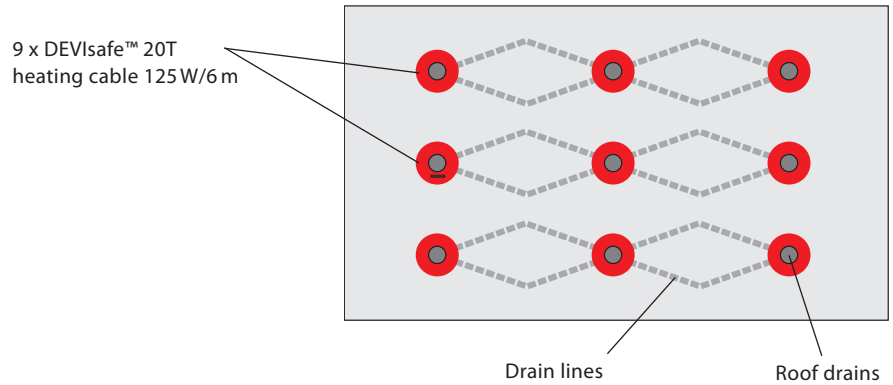

Example 2

Heating drains and roof drainage (depressions).

Installed power:
 $3 \times 2685 \text{ W} = 8055 \text{ kW}$



Example 3

Heating the entire roof surface.

Heated area: $20 \text{ m} \times 40 \text{ m} = 800 \text{ m}^2$.

Installed power:
 $800 \text{ m}^2 \cdot 300 \text{ W/m}^2 = 240 \text{ kW}$.

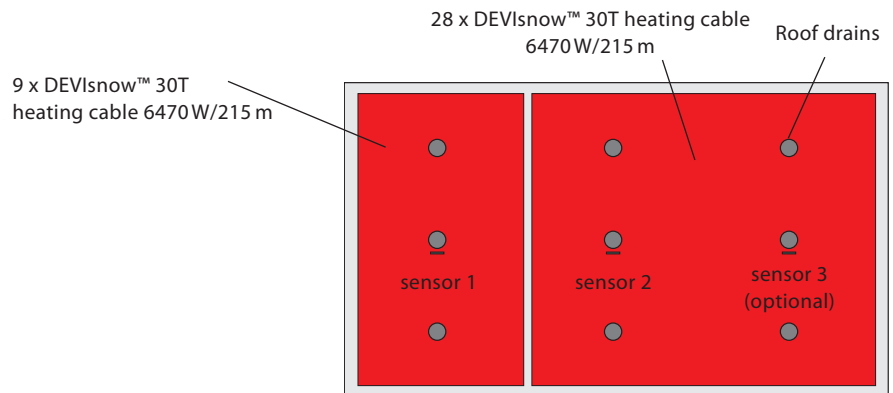

5.1.4 Self-limiting cables installation

These cables are suitable for systems with a large number of short cables located in different parts of the protected roof, e.g. single-family house with multi-surface roof including a large number of dormers and balconies.

In such cases, it is advisable to use DEVIceguard™ 18 self-limiting cable of increased UV resistance.

Self-limiting cable can be cut to any desired length depending on the gutter or drain pipe size and assembled into the installation using a connecting set.

For more complex circuits (e.g. the gutter edge with several downpipes) different junction boxes can be used to connect separate sections in one circuit. For details on self-limiting heating cables refer to the DEVI Catalogue.

The specific feature of DEVIceguard™ 18 self-limiting heating cable is nearly twice increased heat output (from 20 W/m to 36 W/m) under the so-called intensive cooling (cable covered with wet snow or ice).

Increased output improves the system performance right after its start, especially during the initial period.

Due to greater resistance to tensile pull (especially when heated) as compared to the constant wattage heating cables, self-limiting cables avoid the need of chain implementation in downpipes up to 33 m height.

Selection rules (output per meter or area and thermostat type) are the same as described above for DEVIsafe™ 20T and DEVIsnow™ 30T constant wattage cables.



DEVIfast™ Double – perfect solution for installation of self-limiting cables.

Example. Three possible types of self-limiting cable installation

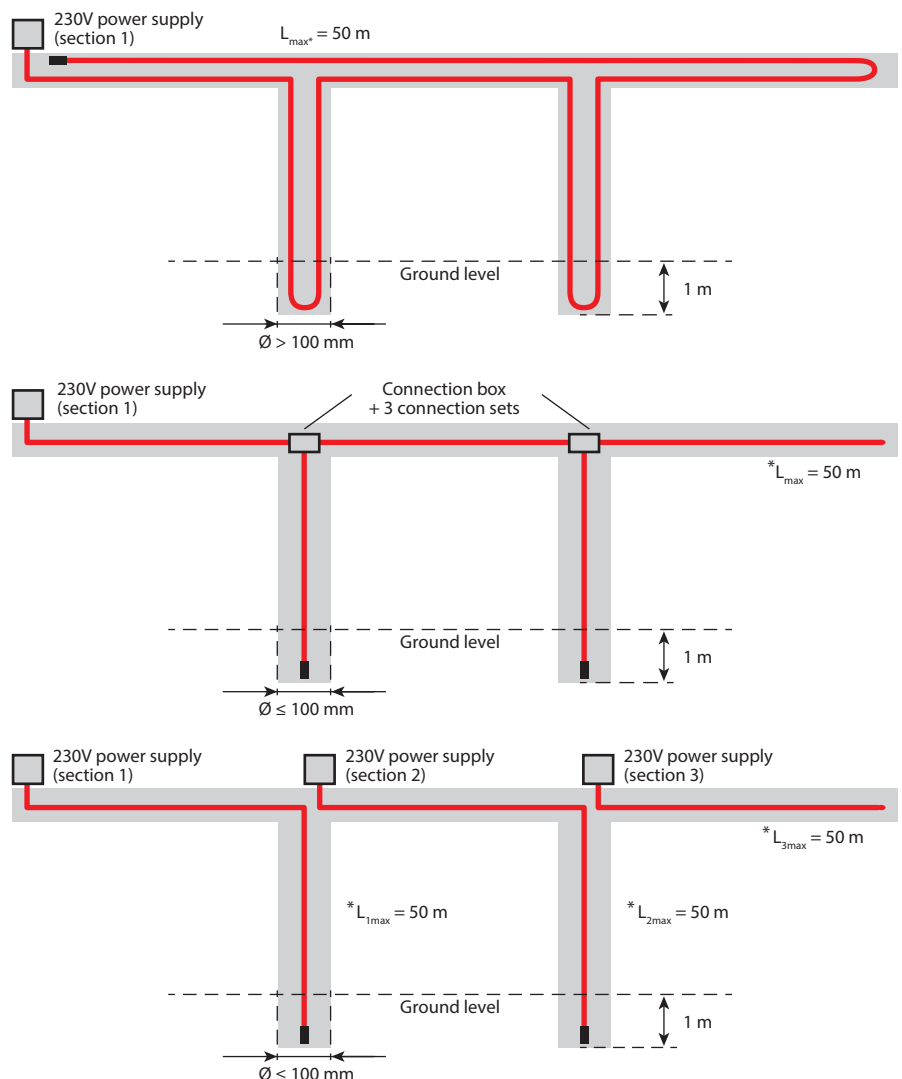





Note!





For gutters and downpipes with more than 100 mm diameter we recommend using two lines of heating cables.

The maximum length of the heating circuit (L_{max}) for DEVliceguard™ 18 for de-icing installations in roof gutters depends on the ambient temperature and the selected fuse type. A detailed list of max. circuit length is shown in a table.

	Fuse (with C characteristic)			
	16 A	20 A	25 A	32 A
	Maximum length of DEVliceguard™ 18			
In gutters, downpipes, etc.	65	80	80	80

A comprehensive range of accessories for self-limiting cables is available. Contact your local representative for details.

Type	
Alutape Tape aluminum, 38 mm x 50 m 2-colour print, for cables	
Connecto B-A Connection	
Connecto B-C Heating tape connection	
Connecto B-E End termination	
Connecto B-S Connection termination	

Type	
Connecto B-T, T-Junction + End termination	
Connecto B-TE2 Junction + 2 End termination	
Connecto B-TE3 Junction + 3 End termination	
Connecto B-X, X-Junction + 2 End termination	
Connecto B-E, Bracket	

5.2 Important

Ensure training of end users on daily monitoring, operation and maintenance of the frost protection system. At the beginning of each season check and remove any sharp edges, leaves and mud from the roof and gutter systems. Also inspect switchboards, thermostats and sensors for any damage.

Sometimes self-limiting cables create a heated tunnel under the snow that results in heat blockage due to its self-limiting characteristics. This can be avoided with constant wattage cables.

2 x 30 W/m is the minimum required for downpipe ø120 mm or more and with a moisture sensitive controller, e.g. DEVlreg™ 850.

Do not install cables in temperatures below -5° C.

Do not cut or cross DEVlsnow™ and DEVIsafe™ constant wattage cables.

Do not connect self-limiting cables with constant wattage cables in series.

Do not interconnect two conductors in a self-limiting cable.

Observe maximum length for self-limiting cables (ref. to Product Data sheet).

Self-limiting cables must be stored in a dry place after being cut to size.

Do not use PVC tape to attach self-limiting cables as it contains plasticizers which can interact with outer sheet of the self-limiting heating cable.

Check Ohm rating (DEVlsnow™ and DEVIsafe™ constant wattage only) and insulation resistance of the cable before and after installation. All electrical works should be performed by authorized personnel in compliance with applicable local regulations.

5.3. Commissioning of thermostats

5.3.1 Roof sensor location

Location of main roof sensors

The first DEVIreg™ 850 roof sensor should be located where snow and ice accumulation causes the biggest problem. If such information for the building is unavailable try to obtain it from the residents. The following locations within the heated area can be used for sensor installation:

- shaded places or locations facing the north-west,
- in the main gutter close to vertical drain pipe.

In the dual system, that comprises of two zones, criteria for the first sensor location are the same for both zones.

Location of additional roof sensors

Additional roof sensors should be installed in places where the roof surface dries at the latest. You can also use the following locations within the heated area:

- places where snow does not slide down into the gutter or the roof slope edge on its own,
- next to other drain pipes,
- at least 1 meter away from other sensors.

Picture shows an example of moisture sensors location on the pent roof, where gutters and drain pipes are protected by the same system/zone for the installation equipped with one sensor (main sensor). To increase the system accuracy additional sensors and cables can be installed adjacent to the roof gutters.

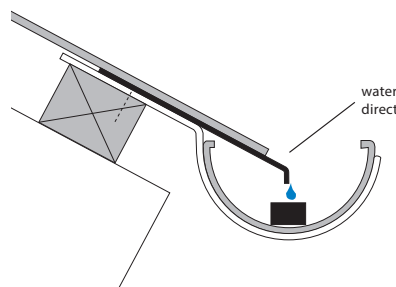
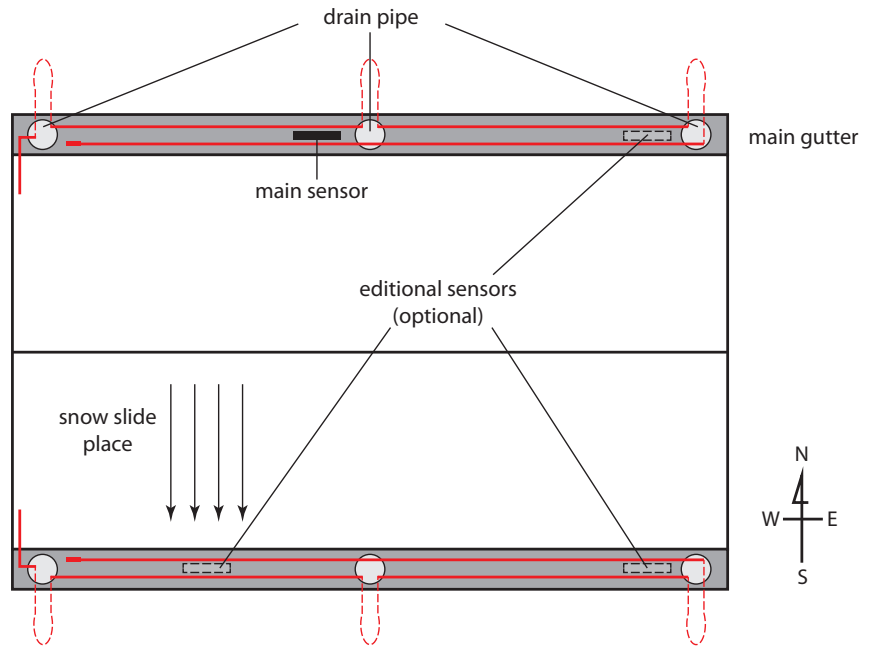

Steep roofs facing south may be exposed to the strong sunlight and as a result fast water dry out. In such cases it may be required to install some additional means to direct water towards a moisture detecting sensor.

To ensure optimal moisture detection it may need several attempts to direct water flow in the right direction.

In case of any doubts concerning the location of the sensor, it is recommended to consider several alternative sites for different configurations.

The sensors are equipped with 15 m connection cable. It enables the sensor connection even if the mounting location is relatively far from the thermostat. In case of longer distance the sensor cable can be extended. An extension cable must comply with the requirements listed in corresponding tables of the Installation guide.

Number of sensors	1 PSU (24 V / 24 W)		2 PSUs (24 V / 48 W)	
	1	2	3	4
Connection cable dimension (mm ²)				
1	400	100	130	75
1,5	600	150	200	110
2,5	1000	250	330	190
4	1600	400	525	300

5.3.2 DEVIreg™ 850 control system

Find detailed information in DEVIreg™ 850 and DEVIreg™ 850 sensor controller Installation and User manuals.

5.3.3 DEVIreg™ 316

To control a small frost protection system DEVIreg™ 330 can be used. For small roof installations an advanced DEVIreg™ 316 version can be applied. DEVIreg™ 316 can run differential mode (described below).

Since first two thermostats operate based on temperature measurements only, it is expected higher running costs comparing with DEVIreg™ 850.

Example of DEVIreg™ 316 operation in differential mode: the thermostat switches ON the heating cable only if temperature is in the range from -8 °C to +2 °C.

It is assumed that it snows only when the temperature is about 0 °C and snowfalls outside this temperature range happen rarely. This is applicable for certain weather conditions only.



DEVIreg™ 316

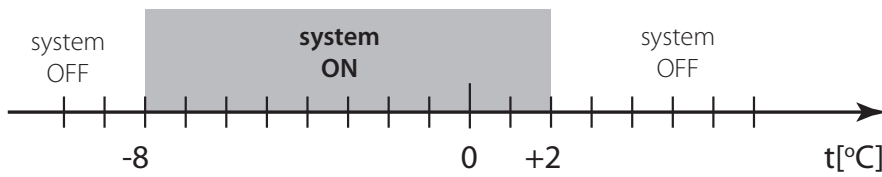

Table 7. Recommended settings of DEVIreg™ 316 and DEVIreg™ 850

Thermostat	Parameter	Recommended settings
DEVIreg™ 316	Low temperature	-8...-6 °C
	High temperature	3...5 °C
DEVIreg™ 850	Melting temperature	1...2 °C
	Post Heat	1-3 hours



5.4 Installations summary

Required tools:

- Hammer
- Chisel
- Glue gun
- Scissor
- Installation manuals



1. Ensure that the roof and the gutter system are heated and remove sharp edges, leaves and mud. Check and prepare the switchboard.

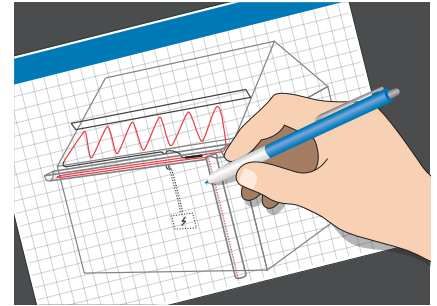

2. Develop the layout plan for cable(s), sensors and thermostats, cable connections/ cold tails, connection box, cable paths and a switchboard. Refer to DEVireg™ 850 manual for location.

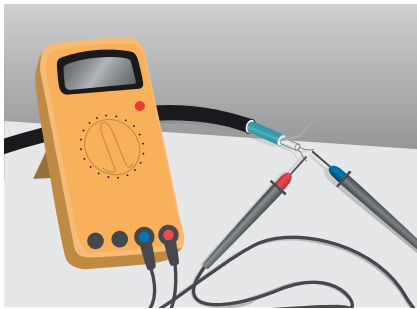

3. Check the insulation resistance and also Ohm rating for constant wattage cables. Install the cable(s) on the roof, in gutters and downpipes.

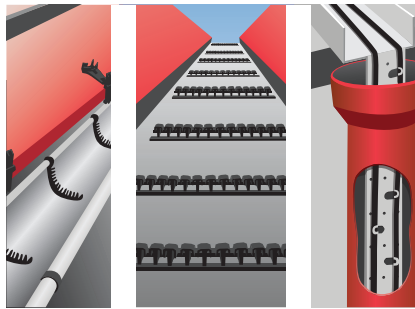

4. Install the connection box and fixing accessories in the gutters, gutter valleys, on the roof and/or the cable.

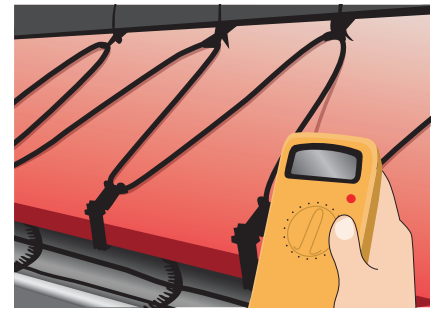

5. Install the cable(s) on the roof, in gutters and downpipes. Check once again and compare the insulation resistance and Ohm rating for constant wattage cables.



6. Install DEVireg™ 850 external sensor, if any, in the gutter according to the sensor manual.

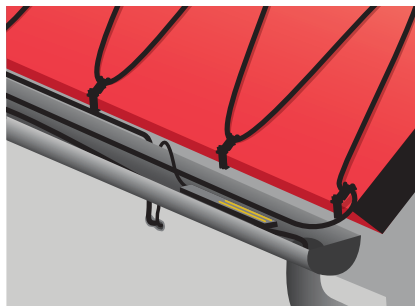

7. Extend sensor cables, cold tails/terminate cables and place connections dry. Seal all penetrations, e.g. through roofs and walls.

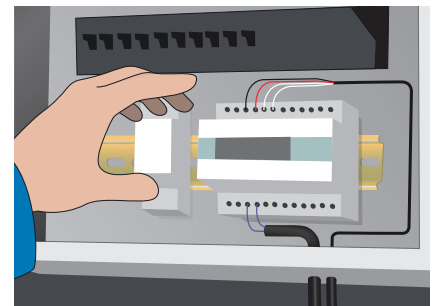

8. Check once again and compare the insulation resistance and Ohm rating for cables. Install DEVireg™ thermostat and connect cables to the connection boxes and to the switchboard.

6. Cases

THE ÖREBRO CASTLE, Örebro, Sweden

The Örebro Castle is a medieval castle fortification situated in the scenic region of Närke, in Sweden.

For the Örebro Castle renovation project the heating cable DEVliceguard™, DEVI Easy Connect and control system DEVIreg™ 850 with humidity and temperature sensors were chosen.

Products:

- DEVliceguard™ – 1000 m
- DEVI Easy Connect
- DEVIreg™ 850



DAHLSKE HIGH SCHOOL, Grimstad, Norway

Originally the builder planned to strengthen the old building with new pillars in order to meet the new building regulations which demand that the roof has a carrying capacity on 400 kg per m². When Dahlske High School was built the carrying capacity was only 250 kg per m².

Instead the builder was convinced that it was a much better solution to install an ice and snow melting system, and DEVI's new twin conductor outdoor heating mats DEVIsnow™ 300T was chosen.

Project size:

- 600 m²

Products:

- DEVIsnow™ 300T

